



**OPEN** Industry Standard, Flexible Architecture

**GREEN** Less Heat, Less Power Consumption

**STABLE** Robust Design, Quality Parts

Stable and  
Reliable Solution

**Server/Workstation**

Motherboard

# EP2C621D12 WS

User Manual

English



Version 1.0

Published December 2018

Copyright©2018 ASRock Rack Inc. All rights reserved.

## Copyright Notice:

No part of this documentation may be reproduced, transcribed, transmitted, or translated in any language, in any form or by any means, except duplication of documentation by the purchaser for backup purpose, without written consent of ASRock Rack Inc.

Products and corporate names appearing in this documentation may or may not be registered trademarks or copyrights of their respective companies, and are used only for identification or explanation and to the owners' benefit, without intent to infringe.

## Disclaimer:

Specifications and information contained in this documentation are furnished for informational use only and subject to change without notice, and should not be constructed as a commitment by ASRock Rack. ASRock Rack assumes no responsibility for any errors or omissions that may appear in this documentation.

With respect to the contents of this documentation, ASRock Rack does not provide warranty of any kind, either expressed or implied, including but not limited to the implied warranties or conditions of merchantability or fitness for a particular purpose.

In no event shall ASRock Rack, its directors, officers, employees, or agents be liable for any indirect, special, incidental, or consequential damages (including damages for loss of profits, loss of business, loss of data, interruption of business and the like), even if ASRock Rack has been advised of the possibility of such damages arising from any defect or error in the documentation or product.



This device complies with Part 15 of the FCC Rules. Operation is subject to the following two conditions:

- (1) this device may not cause harmful interference, and
- (2) this device must accept any interference received, including interference that may cause undesired operation.

## CALIFORNIA, USA ONLY

The Lithium battery adopted on this motherboard contains Perchlorate, a toxic substance controlled in Perchlorate Best Management Practices (BMP) regulations passed by the California Legislature. When you discard the Lithium battery in California, USA, please follow the related regulations in advance.

“Perchlorate Material-special handling may apply, see [www.dtsc.ca.gov/hazardouswaste/perchlorate](http://www.dtsc.ca.gov/hazardouswaste/perchlorate)”

**ASRock Rack's Website: [www.ASRockRack.com](http://www.ASRockRack.com)**

## Contact Information

If you need to contact ASRock Rack or want to know more about ASRock Rack, you're welcome to visit ASRock Rack's website at [www.ASRockRack.com](http://www.ASRockRack.com); or you may contact your dealer for further information.

### **ASRock Rack Incorporation**

6F., No.37, Sec. 2, Jhongyang S. Rd., Beitou District,

Taipei City 112, Taiwan (R.O.C.)

## Contents

<b>Chapter 1 Introduction</b>	<b>1</b>
1.1 Package Contents	1
1.2 Specifications	2
1.3 Unique Features	6
1.4 Motherboard Layout	7
1.5 Onboard LED Indicators	10
1.6 I/O Panel	12
1.7 Block Diagram	15
<b>Chapter 2 Installation</b>	<b>16</b>
2.1 Screw Holes	16
2.2 Pre-installation Precautions	17
2.3 Installing the CPU and Heatsink	18
2.4 Installation of Memory Modules (DIMM)	21
2.5 Expansion Slots (PCI and PCI Express Slots)	24
2.6 Jumper Setup	25
2.7 Onboard Headers and Connectors	28
2.8 Driver Installation Guide	36
2.9 Dual LAN and Teaming Operation Guide	37
2.10 M.2_SSD (NGFF) Module Installation Guide	38
<b>Chapter 3 UEFI Setup Utility</b>	<b>40</b>
3.1 Introduction	40
3.1.1 UEFI Menu Bar	40
3.1.2 Navigation Keys	41

3.2	Main Screen	42
3.3	Advanced Screen	43
3.3.1	CPU Configuration	44
3.3.2	DRAM Configuration	47
3.3.3	Chipset Configuration	49
3.3.4	Storage Configuration	52
3.3.5	ACPI Configuration	54
3.3.6	USB Configuration	55
3.3.7	Super IO Configuration	56
3.3.8	Serial Port Console Redirection	57
3.3.9	H/W Monitor	60
3.3.10	Runtime Error Logging	62
3.3.11	Intel SPS Configuration	64
3.3.12	Overclocking	65
3.3.13	Intel® VMD technology	67
3.3.14	Intel® Virtual RAID on CPU	71
3.3.15	Instant Flash	74
3.4	Security	75
3.4.1	Key Management	76
3.5	Boot Screen	79
3.5.1	CSM Parameters	81
3.6	Event Logs	83
3.7	Server Mgmt	85
3.7.1	System Event Log	86

3.7.2	BMC Network Configuration	87
3.8	Exit Screen	89
<b>Chapter 4 Software Support</b>		<b>90</b>
4.1	Install Operating System	90
4.2	Support CD Information	90
4.2.1	Running The Support CD	90
4.2.2	Drivers Menu	90
4.2.3	Utilities Menu	90
4.2.4	Contact Information	90
<b>Chapter 5 Troubleshooting</b>		<b>91</b>
5.1	Troubleshooting Procedures	91
5.2	Technical Support Procedures	93
5.3	Returning Merchandise for Service	93

# Chapter 1 Introduction

Thank you for purchasing ASRock Rack **EP2C621D12 WS** motherboard, a reliable motherboard produced under ASRock Rack's consistently stringent quality control. It delivers excellent performance with robust design conforming to ASRock Rack's commitment to quality and endurance.

In this manual, chapter 1 and 2 contains introduction of the motherboard and step-by-step guide to the hardware installation. Chapter 3 and 4 contains the configuration guide to BIOS setup and information of the Support CD.



*Because the motherboard specifications and the BIOS software might be updated, the content of this manual will be subject to change without notice. In case any modifications of this manual occur, the updated version will be available on ASRock Rack website without further notice. You may find the latest memory and CPU support lists on ASRock Rack website as well. ASRock Rack's Website: [www.ASRockRack.com](http://www.ASRockRack.com)*

*If you require technical support related to this motherboard, please visit our website for specific information about the model you are using.  
<http://www.asrockrack.com/support/>*

## 1.1 Package Contents

- ASRock Rack **EP2C621D12 WS** Motherboard  
(SSI EEB Form Factor: 12.0-in x 13.0-in, 30.5 cm x 33.0 cm)
- Quick Installation Guide
- Support CD
- 1 x SATA3 Cable (60cm)
- 1 x I/O Shield
- 2 x Screws for M.2 Sockets
- 2 x CPU Fabric Carriers



*If any items are missing or appear damaged, contact your authorized dealer.*

## 1.2 Specifications

<b>EP2C621D12 WS</b>	
<b>MB Physical Status</b>	
Form Factor	SSI EEB
Dimension	12" x 13" (30.5 cm x 33.0 cm)
<b>Processor System</b>	
CPU	Intel® Xeon® Scalable Processors
Socket	Dual Socket LGA-3647
Chipset	Intel® C621
<b>System Memory</b>	
Capacity	- 12 x 288-pin DDR4 DIMM slots - Support up to 64GB DDR4 R DIMM/LR DIMM/NVDIMM
Type	- Six Channel memory technology - Support DDR4 R DIMM/LR DIMM /NVDIMM
Voltage	1.2V
DIMM Size per DIMM	R/LR DIMM: 32GB, 16GB, 8GB, 4GB NVDIMM: 64GB, 32GB
DIMM Frequency	- R DIMM: 2666/2400/2133 MHz - LR DIMM: 2666/2400/2133 MHz - NVDIMM: 2666/2400/2133 MHz
<b>Expansion Slot</b>	
PCIe x16	SLOT1: Gen3 x16 link SLOT3: Gen3 x16 link, auto switch to x8 link if SLOT4 is occupied SLOT5: Gen3 x16 link SLOT6: Gen3 x16 link SLOT7: Gen3 x16 link
PCIe 3.0 x 8	SLOT2: Gen3 x8 link SLOT4: Gen3 x8 link
M.2	2 (2230/2242/2260/2280, support PCIe(x4) or SATA3 M.2)
<b>Storage</b>	
SATA Controller	Intel® C621: 14x SATA3 (including 2 SATA DOM ports and 2 M.2 ports)
M.2	2 (M2_1: support PCIe(x4), from CPU1) & SATA3 6.0Gb/s, form factor: 2230, 2242, 2260, 2280), M2_2: support PCIe(x4) from PCH & SATA3 6.0 Gb/s form factor: 2230, 2242, 2260, 2280)
<b>Audio</b>	
Audio Codec	Realtek ALC892
<b>Ethernet</b>	
Interface	Gigabit LAN



LAN	4 x RJ45 GLAN by Marvell 88E1543 (1000Mb/s) 1 x RJ45 Dedicated IPMI LAN port - Supports Wake-On-LAN - Supports Energy Efficient Ethernet 802.3az - Supports Dual LAN with Teaming function - Supports PXE - LAN1 Supports NCSI
<b>Management</b>	
BMC Controller	ASPEED AST2500 : IPMI (Intelligent Platform Management Interface) 2.0 with Ikmv and vMedia support
IPMI Dedicated GLAN	1 x Realtek RTL8211E for dedicated management GLAN
Features	- Watch Dog - NMI
<b>Graphics</b>	
Controller	ASPEED AST2500
VRAM	DDR4 256Mb
<b>Rear Panel I/O</b>	
VGA Port	1 x D-Sub
USB 3.0 Port	2
LAN Port	- 4+1 RJ45 Gigabit Ethernet LAN port - LAN Ports with LED (ACT/LINK LED and SPEED LED)
Audio	3
<b>Internal Connector</b>	
Auxiliary Panel Header	1 (includes chassis intrusion, location button & LED, front LAN LED)
TPM Header	1
IPMB Header	1
Front VGA Header	1
Fan Header	7 Fans(CPU1/CPU2/4Front/1Rear))
ATX Power	1x (24-pin) + 1x (8-pin) + 1x (8-pin)
USB 3.0 Header	1 ( support 2 USB 3.0)
USB 2.0 Header	1 ( support 2 USB 2.0)
M.2	2 (M2_1: support PCIE(x4), from CPU1) & SATA3 6.0Gb/s, form factor: 2230, 2242, 2260, 2280), M2_2: support PCIE(x4) from PCH & SATA3 6.0 Gb/s form factor: 2230, 2242, 2260, 2280)
Type A USB 3.0 Port	1
SATA DOM	2 (SSATA)
PSU SMB Header	1
SATA RAID Key	1
NMI Header	1
ME_Recovery	1

Front Panel Header	1
Front LAN LED Header	1
Speaker(4pin)	1
SGPIO	3
Audio Header	1
COM Header	1
BMC_SMBI	1
OH/FanFail LED	7 (only Fan Fail LED)
<b>System BIOS</b>	
BIOS Type	256Mb AMI UEFI Legal BIOS
BIOS Features	<ul style="list-style-type: none"> <li>- Plug and Play (PnP)</li> <li>- ACPI 2.0 Compliance Wake Up Events</li> <li>- SMBIOS 2.8 Support</li> <li>- ASRock Rack Instant Flash</li> </ul>
<b>Hardware Monitor</b>	
Temperature	<ul style="list-style-type: none"> <li>- CPU Temperature Sensing</li> <li>- System Temperature Sensing</li> </ul>
Fan	<ul style="list-style-type: none"> <li>- CPU/Rear/Front Fan Tachometer</li> <li>- CPU Quiet Fan (Allow Chassis Fan Speed Auto-Adjust by CPU Temperature)</li> <li>- CPU/Rear/Front Fan Multi-Speed Control</li> </ul>
Voltage	Voltage Monitoring: +12V, +5V, +3.3V, CPU Vcore, DRAM, 1.05V_PCH, +BAT, 3VSB, 5VSB
<b>Support OS</b>	
OS	<p>Microsoft® Windows® (Server OS)</p> <ul style="list-style-type: none"> <li>- Server 2012 R2 (64 bit)</li> <li>- Server 2016 (64 bit)</li> </ul> <p>Microsoft® Windows® (Client OS)</p> <ul style="list-style-type: none"> <li>- Windows 10 (64 bit)</li> </ul> <p>Linux®</p> <ul style="list-style-type: none"> <li>- RedHat Enterprise Linux Server 6.8 (64 bit) / 7.4 (64 bit)</li> <li>- CentOS 6.8 (64 bit) / 7.4 (64 bit)</li> <li>- SUSE Enterprise Linux Server 11 SP4 (64 bit) / 12 SP3 (64 bit)</li> <li>- Ubuntu 16.04 (64 bit) / 15.10 (64 bit)</li> <li>- FreeBSD 11.2 (64 bit)</li> </ul> <p>Virtual</p> <ul style="list-style-type: none"> <li>- VMWare® ESXi 6.5</li> </ul> <p><i>*Please refer to our website for the latest OS support list. *On Ubuntu 16.04 (64bit) system, Intel Raid mode only supports UEFI BOOT.</i></p>

**Environment****Temperature**

Operation temperature: 10°C ~ 35°C / Non operation temperature: -40°C ~ 70°C



*This motherboard supports Wake from on Board LAN. To use this function, please make sure that the "Wake on Magic Packet from power off state" is enabled in Device Manager > Intel® Ethernet Connection > Power Management. And the "PCI Devices Power On" is enabled in UEFI SETUP UTILITY > Advanced > ACPI Configuration. After that, onboard LAN1 ~ LAN4 can wake up S5 under OS.*



*If you install Intel® LAN utility or Marvell SATA utility, this motherboard may fail Windows® Hardware Quality Lab (WHQL) certification tests. If you install the drivers only, it will pass the WHQL tests.*

## 1.3 Unique Features

ASRock Rack Instant Flash is a BIOS flash utility embedded in Flash ROM. This convenient BIOS update tool allows you to update system BIOS without entering operating systems first like MS-DOS or Windows. With this utility, you can press the <F6> key during the POST or the <F2> key to enter into the BIOS setup menu to access ASRock Rack Instant Flash. Just launch this tool and save the new BIOS file to your USB flash drive, floppy disk or hard drive, then you can update your BIOS only in a few clicks without preparing an additional floppy diskette or other complicated flash utility. Please be noted that the USB flash drive or hard drive must use FAT32/16/12 file system.

# 1.4 Motherboard Layout

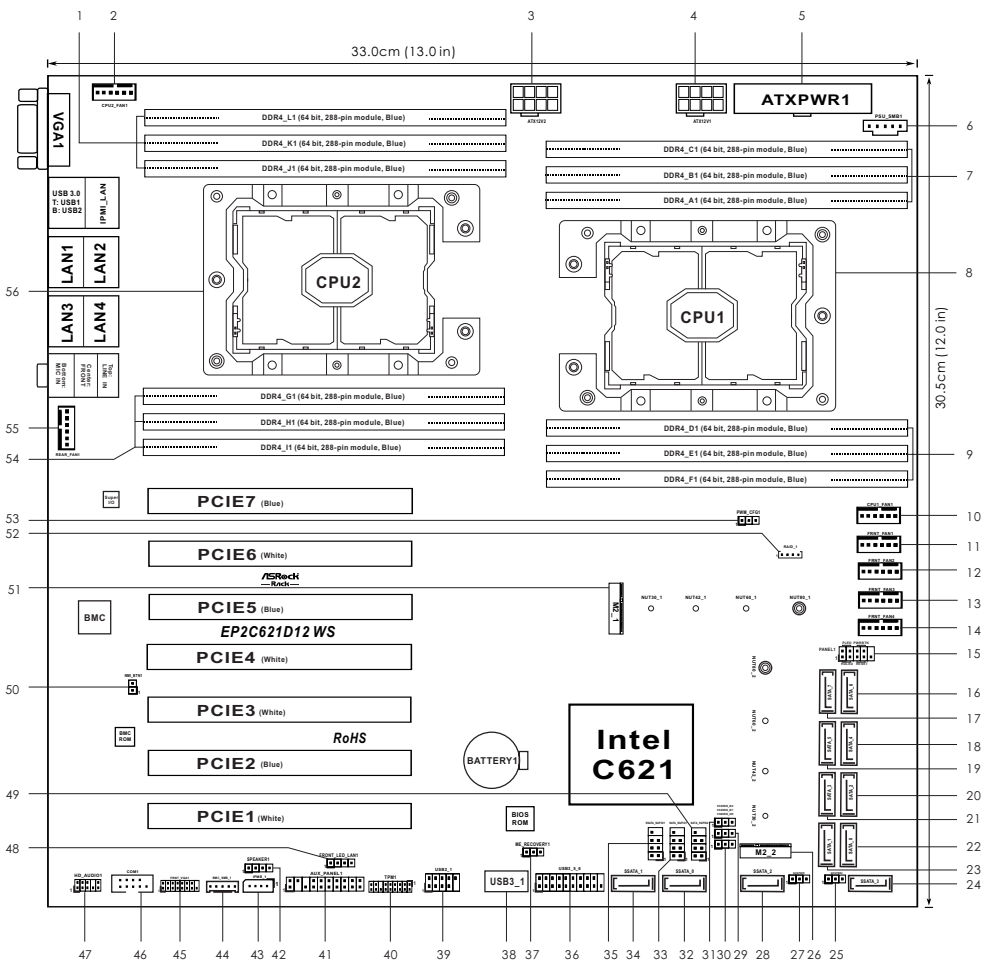

No.	Description
1	3 x 288-pin DDR4 DIMM Slots (DDR4_J1, DDR4_K1, DDR4_L1)*
2	CPU2 Fan Connector (CPU2_FAN1)
3	ATX 12V Power Connector (ATX12V2)
4	ATX 12V Power Connector (ATX12V1)
5	ATX Power Connector (ATXPWR1)
6	PSU SMBus Header (PSU_SMB1)
7	3 x 288-pin DDR4 DIMM Slots (DDR4_A1, DDR4_B1, DDR4_C1)*
8	LGA 3647 CPU Socket (CPU1)
9	3 x 288-pin DDR4 DIMM Slots (DDR4_D1, DDR4_E1, DDR4_F1)*
10	CPU1 Fan Connector (CPU1_FAN1)
11	Front Fan Connector (FRNT_FAN1)
12	Front Fan Connector (FRNT_FAN2)
13	Front Fan Connector (FRNT_FAN3)
14	Front Fan Connector (FRNT_FAN4)
15	System Panel Header (PANEL1)
16	SATA3 Connector (SATA_6), White
17	SATA3 Connector (SATA_7), White
18	SATA3 Connector (SATA_4), White
19	SATA3 Connector (SATA_5), White
20	SATA3 Connector (SATA_2), White
21	SATA3 Connector (SATA_3), White
22	SATA3 Connector (SATA_0), White
23	SATA3 Connector (SATA_1), White
24	SATA3 DOM Connector (SSATA_3), Red
25	SATA DOM Power Jumper (SATAPWR2)
26	M.2 Socket (M2_2) (Type 2230 / 2242 / 2260 / 2280)
27	SATA DOM Power Jumper (SATAPWR1)
28	SATA3 DOM Connector (SSATA_2), Red
29	Chassis ID1 Jumper (CHASSIS_ID1)
30	Chassis ID0 Jumper (CHASSIS_ID0)
31	Chassis ID2 Jumper (CHASSIS_ID2)
32	SATA3 Connector (SSATA_0), White
33	SATA SGPIO Connector (SATA_SGPIO)

No.	Description
34	SATA3 Connector (SSATA_1), White
35	SATA SGPIO Connector (SSATA_SGPIO1)
36	USB 3.0 Header (USB3_5_6)
37	ME Recovery Jumper (ME_RECOVERY1)
38	Vertical Type A USB 3.0 (USB3_1)
39	USB 2.0 Header (USB2_1)
40	TPM Header (TPM1)
41	Auxiliary Panel Header (AUX_PANEL1)
42	Speaker Header (SPEAKER1)
43	Intelligent Platform Management Bus header (IPMB_1)
44	BMC SMBus Header (BMC_SMB_1)
45	Front VGA Header (FRNT_VGA1)
46	Serial Port Header (COM1)
47	Front Panel Audio Header (HD_AUDIO1)
48	Front LAN LED Connector (FRONT_LED_LAN1)
49	SATA SGPIO Connector (SATA_SGPIO2)
50	Non Maskable Interrupt Button (NMI_BTN1)
51	M.2 Socket (M2_1) (Type 2230 / 2242 / 2260 / 2280)
52	Virtual RAID On CPU Header (RAID_1)
53	PWM Configuration Header (PWM_CFG1)
54	3 x 288-pin DDR4 DIMM Slots (DDR4_G1, DDR4_H1, DDR4_I1)*
55	Rear Fan Connector (REAR_FAN1)
56	LGA 3647 CPU Socket (CPU2)

*\*For DIMM installation and configuration instructions, please see p.21 (Installation of Memory Modules (DIMM)) for more details.*

# 1.5 Onboard LED Indicators

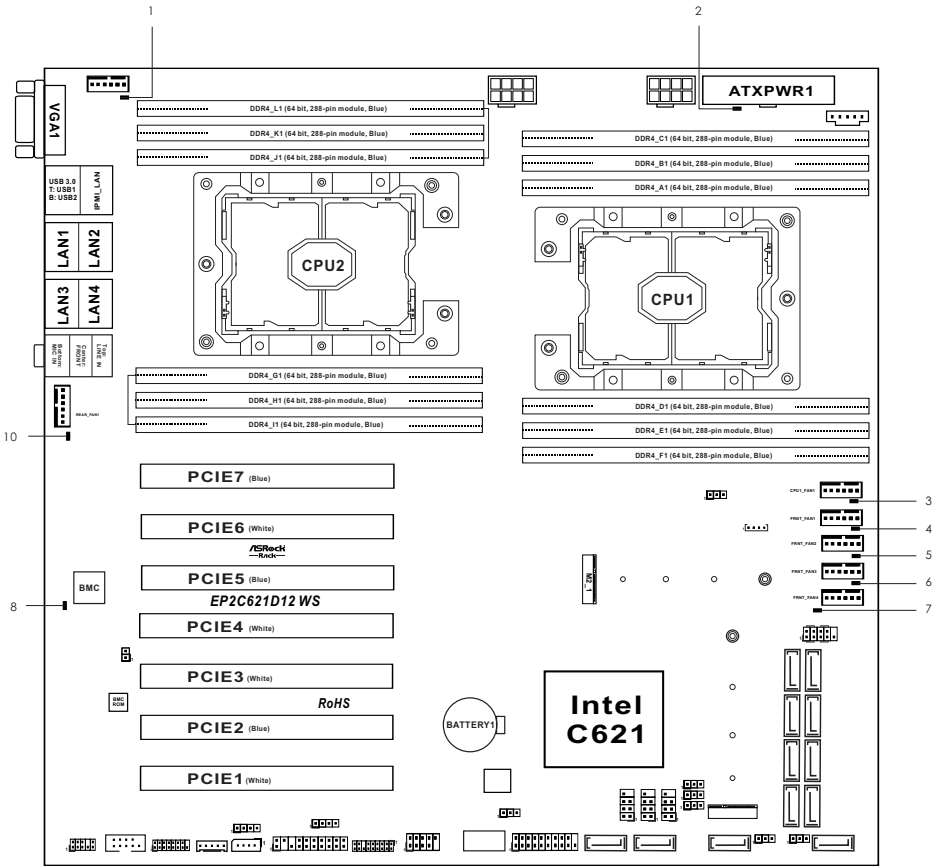



No.	Item	Status	Description
1	FAN_LED2	Amber	CPU2_FAN1 failed
2	SB_PWR1	Green	STB PWR ready
3	FAN_LED1	Amber	CPU1_FAN1 failed
4	FAN_LED4	Amber	FRNT_FAN1 failed
5	FAN_LED5	Amber	FRNT_FAN2 failed
6	FAN_LED6	Amber	FRNT_FAN3 failed
7	FAN_LED7	Amber	FRNT_FAN4 failed
8	BMC_LED1	Green	BMC heartbeat LED
9	FAN_LED3	Amber	REAR_FAN1 failed

## 1.6 I/O Panel

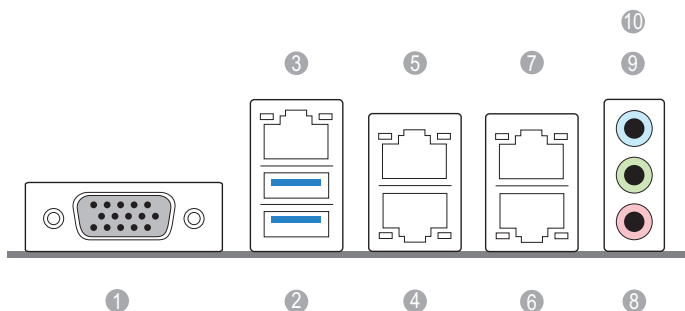

No.	Description	No.	Description
1	VGA Port (VGA1)	6	GLAN RJ-45 Port (LAN3)**
2	USB 3.0 Ports (USB3_1_2)	7	GLAN RJ-45 Port (LAN4)**
3	LAN RJ-45 Port (IPMI_LAN)*	8	Microphone (Pink)***
4	GLAN RJ-45 Port (LAN1)**	9	Front Speaker (Lime)***
5	GLAN RJ-45 Port (LAN2)**	10	Line In (Light Blue)***

### LAN Port LED Indications

\*There are two LED next to the LAN port. Please refer to the table below for the LAN port LED indications.

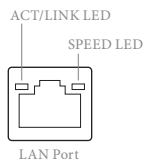

### Dedicated IPMI LAN Port LED Indications

Activity / Link LED		Speed LED	
Status	Description	Status	Description
Off	No Link	Off	10M bps connection or no link
Blinking Yellow	Data Activity	Yellow	100M bps connection
On	Link	Green	1G bps connection

**LAN Port LED Indications**

\*There are two LED next to the LAN port. Please refer to the table below for the LAN port LED indications.

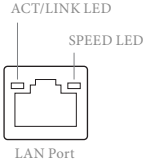

**LAN (LAN1, LAN2, LAN3, LAN4) Port LED Indications**

Activity / Link LED		Speed LED	
Status	Description	Status	Description
Off	No Link	Off	No link
Blinking Yellow	Data Activity	Green	1Gbps connection
On	Link		

\*\*\* To configure 7.1 CH HD Audio, it is required to use an HD front panel audio module and enable the multi-channel audio feature through the audio driver.

Please set Speaker Configuration to "7.1 Speaker" in the Realtek HD Audio Manager.

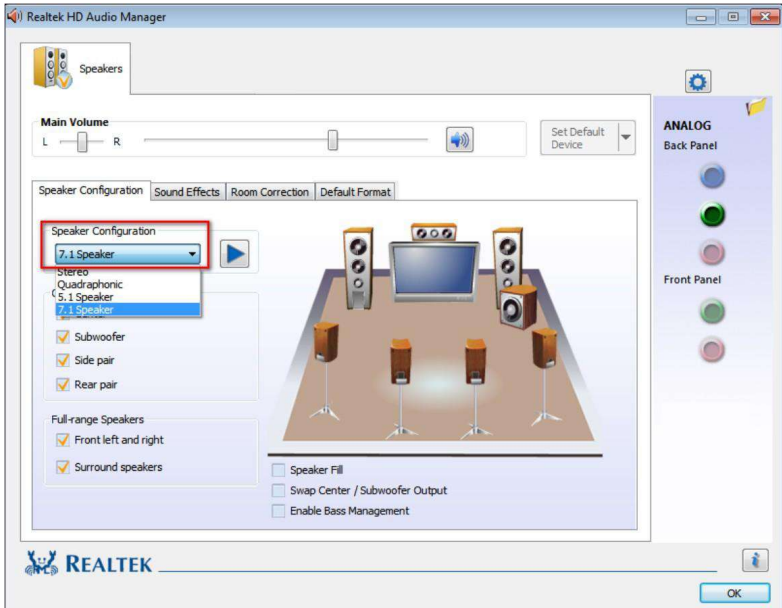

Function of the Audio Ports in 7.1-channel Configuration:

Port	Function
Light Blue (Rear panel)	Rear Speaker Out
Lime (Rear panel)	Front Speaker Out
Pink (Rear panel)	Central /Subwoofer Speaker Out
Lime (Front panel)	Side Speaker Out

# 1.7 Block Diagram

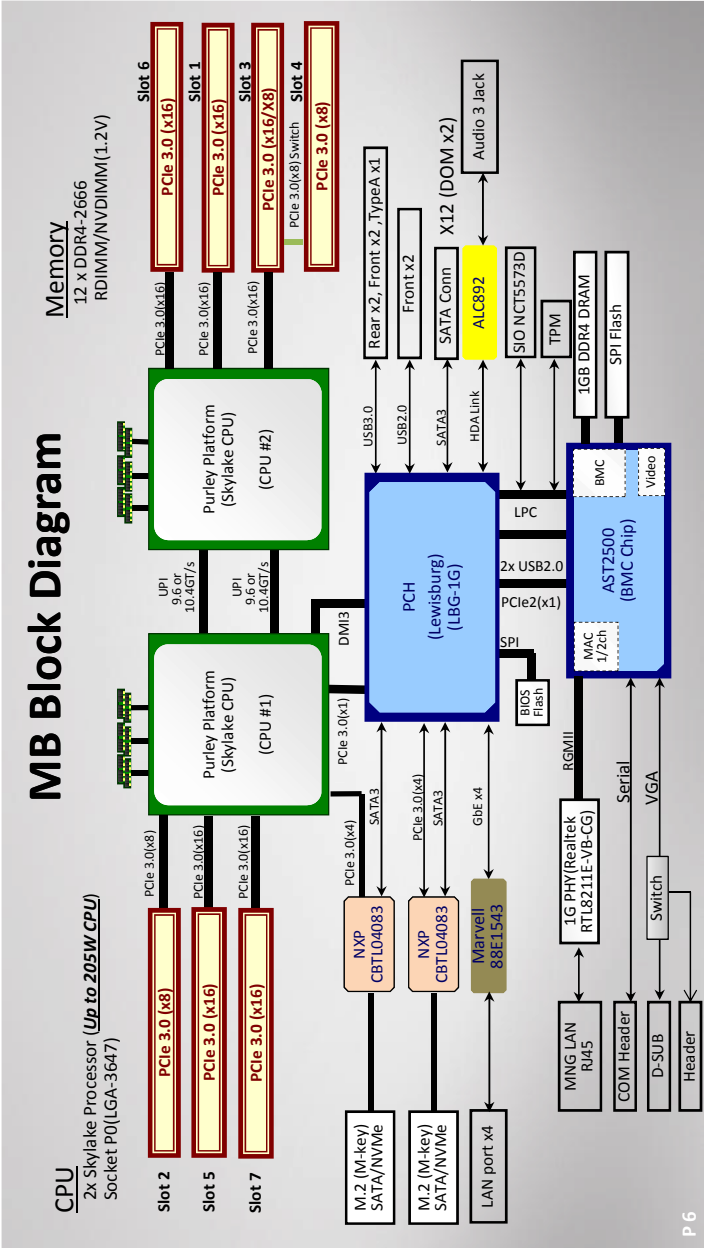

# Chapter 2 Installation

This is a SSI EEB form factor (12" x 13", 30.5 cm x 33.0 cm) motherboard. Before you install the motherboard, study the configuration of your chassis to ensure that the motherboard fits into it.



*Make sure to unplug the power cord before installing or removing the motherboard. Failure to do so may cause physical injuries to you and damages to motherboard components.*

## 2.1 Screw Holes

Place screws into the holes indicated by circles to secure the motherboard to the chassis.



*Attention! Before installing this motherboard, be sure to unscrew and remove the standoff at the marked location, under the motherboard, from the chassis, in order to avoid electrical short circuit and damage to your motherboard.*



*Do not over-tighten the screws! Doing so may damage the motherboard.*

## 2.2 Pre-installation Precautions

Take note of the following precautions before you install motherboard components or change any motherboard settings.

1. Unplug the power cord from the wall socket before touching any components.
2. To avoid damaging the motherboard's components due to static electricity, NEVER place your motherboard directly on the carpet or the like. Also remember to use a grounded wrist strap or touch a safety grounded object before you handle the components.
3. Hold components by the edges and do not touch the ICs.
4. Whenever you uninstall any component, place it on a grounded anti-static pad or in the bag that comes with the component.
5. When placing screws into the screw holes to secure the motherboard to the chassis, please do not over-tighten the screws! Doing so may damage the motherboard.



*Before you install or remove any component, ensure that the power is switched off or the power cord is detached from the power supply. Failure to do so may cause severe damage to the motherboard, peripherals, and/or components.*

## 2.3 Installing the CPU and Heatsink



1. Before you insert the CPU into the socket, please check if the PnP cap is on the socket, if the CPU surface is unclean, or if there are any bent pins in the socket. Do not force to insert the CPU into the socket if above situation is found. Otherwise, the CPU will be seriously damaged.
2. Unplug all power cables before installing the CPU.

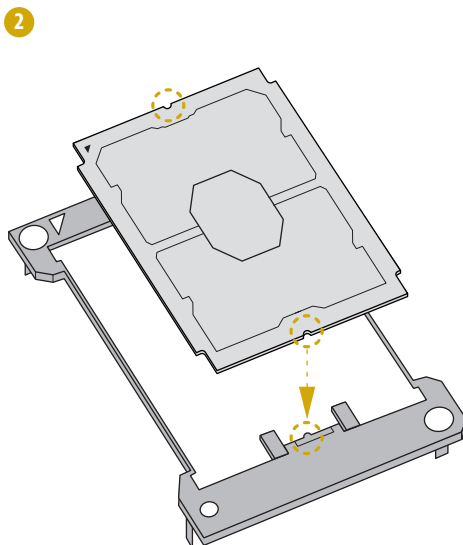
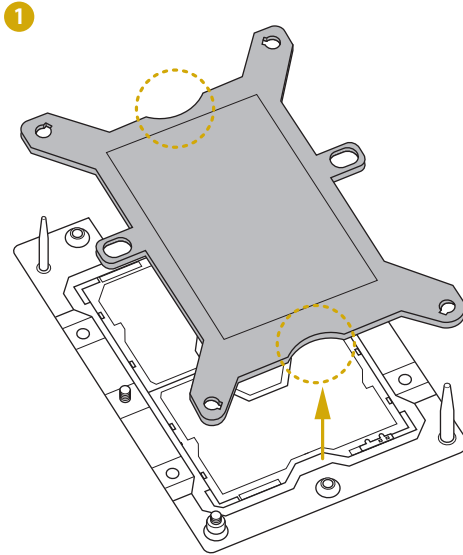





1. Before you installed the heatsink, you need to spray thermal interface material between the CPU and the heatsink to improve heat dissipation.
2. Illustration in this documentation are examples only. Heatsink or fan cooler type may differ.

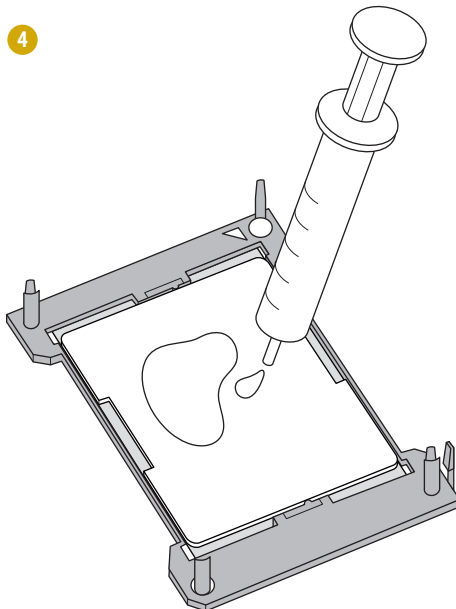
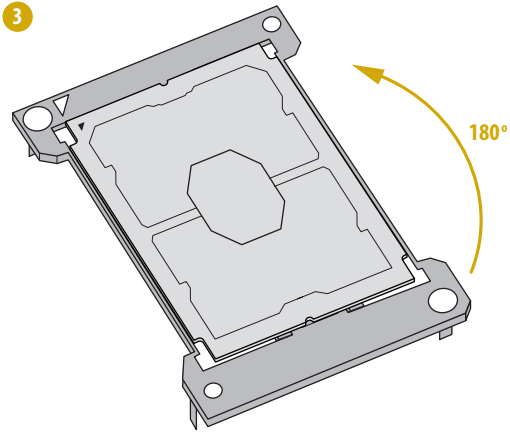

6

Tighten the two  
Middle Nuts to  
12 IN.LB.  
Two turns at a time.

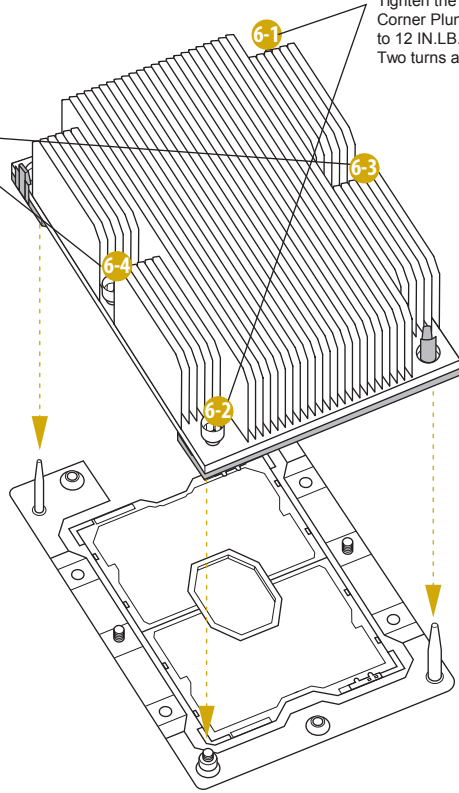

Tighten the two  
Corner Plunger  
to 12 IN.LB.  
Two turns at a time.

## 2.4 Installation of Memory Modules (DIMM)

This motherboard provides twelve 288-pin DDR4 (Double Data Rate 4) DIMM slots in two groups, and supports Six and Dual Channel Memory Technology.

Capacity	CPU1	CPU2
256GB / 512GB	DDR4_A1, B1, C1, D1, E1, F1	DDR4_G1, H1, I1, J1, K1, L1



1. It is not allowed to install a DDR, DDR2 or DDR3 memory module into a DDR4 slot; otherwise, this motherboard and DIMM may be damaged.
2. For dual channel configuration, you always need to install identical (the same brand, speed, size and chip-type) DDR4 DIMM pairs.
3. It is unable to activate Dual Channel Memory Technology with only one or three memory module installed.
4. Some DDR4 1GB double-sided DIMMs with 16 chips may not work on this motherboard. It is not recommended to install them on this motherboard.

1

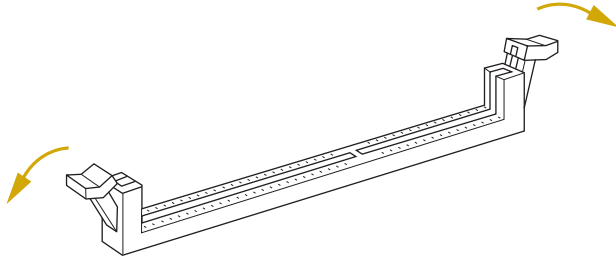

2

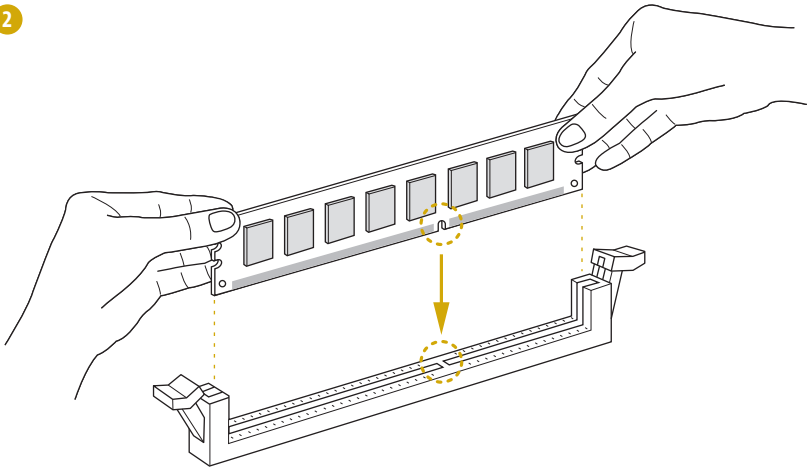

3

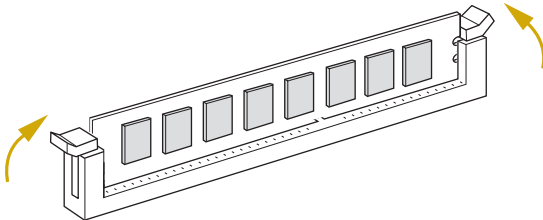

## Recommended Memory Configurations

A single memory module should be installed in the socket which is nearest to the CPU.

### 1 CPU Configuration

	CPU1					
	A1	B1	C1	D1	E1	F1
1 DIMM	#					
2 DIMMS	#			#		
4 DIMMS	#	#		#	#	
6 DIMMS	#	#	#	#	#	#

### 2 CPU Configuration

	CPU1					
	A1	B1	C1	D1	E1	F1
1 DIMM	#					
2 DIMMS	#			#		
4 DIMMS	#	#		#	#	
6 DIMMS	#	#	#	#	#	#

	CPU2					
	G1	H1	I1	J1	K1	L1
1 DIMM	#					
2 DIMMS	#			#		
4 DIMMS	#	#		#	#	
6 DIMMS	#	#	#	#	#	#

Note: "#" indicates the socket is populated with a memory module.

## 2.5 Expansion Slots (PCI and PCI Express Slots)

There are 7 PCI Express slots on this motherboard.

### PCIe slot:

PCIe1, PCIe3, PCIe4 and PCIe6 (PCIe 3.0 x16 slot, from CPU2) are used for PCI Express x16 lane width cards.

PCIe2 (PCIe 3.0 x16 slot, from CPU1) is used for PCI Express x8 lane width cards.

PCIe5 and PCIe7 (PCIe 3.0 x16 slot, from CPU1) are used for PCI Express x16 lane width cards.

Slot	Generation	Mechanical	Electrical	Source
PCIe 7	3.0	x16	x16	CPU1
PCIe 6	3.0	x16	x16	CPU2
PCIe 5	3.0	x16	x16	CPU1
PCIe 4	3.0	x16	x8	CPU2
PCIe 3	3.0	x16	x16	CPU2
PCIe 2	3.0	x16	x8	CPU1
PCIe 1	3.0	x16	x16	CPU2

### PCI Express Slot Configuration

	PCIe 3	PCIe 4
Single PCIe Card	x16	x0
Two PCIe Cards	x8	x8

### Installing an expansion card

- Step 1. Before installing an expansion card, please make sure that the power supply is switched off or the power cord is unplugged. Please read the documentation of the expansion card and make necessary hardware settings for the card before you start the installation.
- Step 2. Remove the system unit cover (if your motherboard is already installed in a chassis).
- Step 3. Remove the bracket facing the slot that you intend to use. Keep the screws for later use.
- Step 4. Align the card connector with the slot and press firmly until the card is completely seated on the slot.
- Step 5. Fasten the card to the chassis with screws.
- Step 6. Replace the system cover.

## 2.6 Jumper Setup

The illustration shows how jumpers are setup. When the jumper cap is placed on the pins, the jumper is “Short”. If no jumper cap is placed on the pins, the jumper is “Open”. The illustration shows a 3-pin jumper whose pin1 and pin2 are “Short” when a jumper cap is placed on these 2 pins.

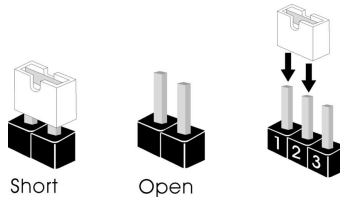

ME Recovery Jumper  
(3-pin ME\_RECOVERY1)  
(see p.7, No. 37)



Normal Mode (Default)



ME Recovery Mode

### Chassis ID Jumpers

Chassis ID0 Jumper  
(3-pin CHASSIS\_ID0)  
(see p.7, No. 30)



Chassis ID1 Jumper  
(3-pin CHASSIS\_ID1)  
(see p.7, No. 29)



Chassis ID2 Jumper  
(3-pin CHASSIS\_ID2)  
(see p.7, No. 31)



Board Level SKU (Default)

Reserved for system level  
use

Chassis ID0 Jumper  
(3-pin CHASSIS\_ID0)  
(see p.7, No. 30)



Chassis ID1 Jumper  
(3-pin CHASSIS\_ID1)  
(see p.7, No. 29)



Chassis ID2 Jumper  
(3-pin CHASSIS\_ID2)  
(see p.7, No. 31)



Reserved for system level  
use



Reserved for system level  
use

Chassis ID0 Jumper (3-pin CHASSIS_ID0) (see p.7, No. 30)		
Chassis ID1 Jumper (3-pin CHASSIS_ID1) (see p.7, No. 29)		
Chassis ID2 Jumper (3-pin CHASSIS_ID2) (see p.7, No. 31)		
	Reserved for system level use	Reserved for system level use
Chassis ID0 Jumper (3-pin CHASSIS_ID0) (see p.7, No. 30)		
Chassis ID1 Jumper (3-pin CHASSIS_ID1) (see p.7, No. 29)		
Chassis ID2 Jumper (3-pin CHASSIS_ID2) (see p.7, No. 31)		
	Reserved for system level use	Reserved for system level use
SATA DOM Power Jumpers (3-pin SATAPWR1) (see p.7, No.27)		
	SATA DOM (SSATA_2) requires 5V power supply	SATA DOM (SSATA_2) does NOT require 5V power supply (Default)
(3-pin SATAPWR2) (see p.7, No.25)		
	SATA DOM (SSATA_3) requires 5V power supply	SATA DOM (SSATA_3) does NOT require 5V power supply (Default)





*Consult the documentation that comes with your SATA DOM and check whether or not Pin 7 requires 5V power supply.*

*If the connected SATA DOM requires 5V power supply, move the jumper caps placed on the SATA DOM Power Jumper (SATAPWR1 / SATAPWR2) from pins 2-3 (default) to pins 1-2.*

*If the connected SATA DOM does NOT require 5V power supply, connect the SATA DOM power cable to the SATA DOM power header (SATAPWR1 / SATAPWR2) and there is no need to change the default jumper setting of the SATA DOM Power Jumper (pins 2-3).*

*Warning! Incorrect setting of the SATA DOM Power Jumper (SATAPWR1 / SATAPWR2) may cause damage to the motherboard or your SATA DOM.*

## 2.7 Onboard Headers and Connectors



Onboard headers and connectors are NOT jumpers. Do NOT place jumper caps over these headers and connectors. Placing jumper caps over the headers and connectors will cause permanent damage to the motherboard.

System Panel Header  
(9-pin PANEL1)  
(see p.7, No. 15)

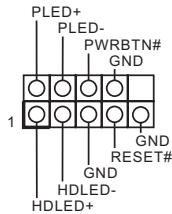

Connect the power switch, reset switch and system status indicator on the chassis to this header according to the pin assignments. Particularly note the positive and negative pins before connecting the cables.



**PWRBTN (Power Switch):**

Connect to the power switch on the chassis front panel. You may configure the way to turn off your system using the power switch.

**RESET (Reset Switch):**

Connect to the reset switch on the chassis front panel. Press the reset switch to restart the computer if the computer freezes and fails to perform a normal restart.

**PLED (System Power LED):**

Connect to the power status indicator on the chassis front panel. The LED is on when the system is operating. The LED is off when the system is in S4 sleep state or powered off (S5).

**HDLED (Hard Drive Activity LED):**

Connect to the hard drive activity LED on the chassis front panel. The LED is on when the hard drive is reading or writing data.

The front panel design may differ by chassis. A front panel module mainly consists of power switch, reset switch, power LED, hard drive activity LED, speaker and etc. When connecting your chassis front panel module to this header, make sure the wire assignments and the pin assignments are matched correctly.

### Auxiliary Panel Header (18-pin AUX PANEL1) (see p.7, No. 41)

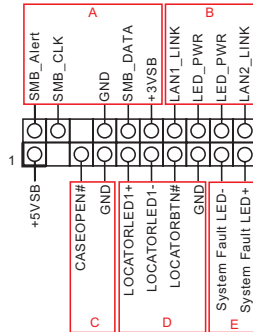

This header supports multiple functions on the front panel, including the front panel SMB, internet status indicator and chassis intrusion pin.



#### A. Front panel SMBus connecting pin (6-1 pin FPSMB)

This header allows you to connect SMBus (System Management Bus) equipment. It can be used for communication between peripheral equipment in the system, which has slower transmission rates, and power management equipment.

#### B. Internet status indicator (2-pin LAN1\_LED, LAN2\_LED)

These two 2-pin headers allow you to use the Gigabit internet indicator cable to connect to the LAN status indicator. When this indicator flickers, it means that the internet is properly connected.

#### C. Chassis intrusion pin (2-pin CHASSIS)

This header is provided for host computer chassis with chassis intrusion detection designs. In addition, it must also work with external detection equipment, such as a chassis intrusion detection sensor or a microswitch. When this function is activated, if any chassis component movement occurs, the sensor will immediately detect it and send a signal to this header, and the system will then record this chassis intrusion event. The default setting is set to the CASEOPEN and GND pin; this function is off.

#### D. Locator LED (4-pin LOCATOR)

This header is for the locator switch and LED on the front panel.

#### E. System Fault LED (2-pin LOCATOR)

This header is for the Fault LED on the system.

### Front VGA Header (15-pin FRNT\_VGA1) (see p.7, No. 45)

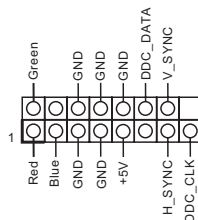

Please connect either end of VGA\_2X8 cable to VGA header.

---

### Serial ATA3 Connectors

- (SATA\_0)
- (see p.7, No. 22)
- (SATA\_1)
- (see p.7, No. 23)
- (SATA\_2)
- (see p.7, No. 20)
- (SATA\_3)
- (see p.7, No. 21)
- (SATA\_4)
- (see p.7, No. 18)
- (SATA\_5)
- (see p.7, No. 19)
- (SATA\_6)
- (see p.7, No. 16)
- (SATA\_7)
- (see p.7, No. 17)
- (SSATA\_0)
- (see p.7, No. 32)
- (SSATA\_1)
- (see p.7, No. 34)

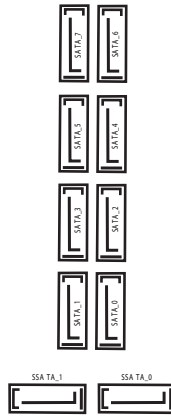

These ten SATA3 connectors support SATA data cables for internal storage devices with up to 6.0 Gb/s data transfer rate.

---

### Serial ATA3 DOM

- #### Connectors
- (SSATA\_2)
  - (see p.7, No. 28)
  - (SSATA\_3)
  - (see p.7, No. 24)



The SATA3 DOM connectors support both a SATA DOM (Disk-On-Module) and a SATA data cable for internal storage device.

---

### USB 3.0 Connector

- (USB3\_1)
- (see p.7, No. 38)



USB 3.0 Header  
 (19-pin USB3\_5\_6)  
 (see p.7, No. 36)

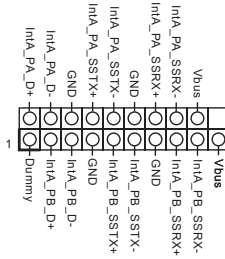

Besides two default USB 3.0 ports on the I/O panel, there is one USB 3.0 header on this motherboard. This USB 3.0 header can support two USB 3.0 ports.

USB 2.0 Header  
 (19-pin USB2\_1)  
 (see p.7, No. 39)

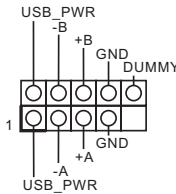

There is one USB 2.0 header on this motherboard. This USB 2.0 header can support two USB 2.0 ports.

Chassis Speaker Header  
 (4-pin SPEAKER1)  
 (see p.7, No. 42)

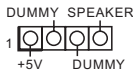

Please connect the chassis speaker to this header.

CPU Fan Connectors  
 (4-pin CPU1\_FAN1)  
 (see p.7, No. 10)  
 (4-pin CPU2\_FAN1)  
 (see p.7, No. 2)

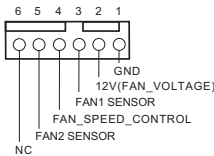

This motherboard provides two 6-Pin CPU fan (Quiet Fan) connectors. If you plan to connect a 3-Pin CPU fan, please connect it to Pin 1-3.

*\*For more details, please refer to the Cooler QVL list on the ASRock Rack website.*

---

## Front and Rear Fan Connectors

- (4-pin FRNT\_FAN1) (see p.7, No. 11)
- (4-pin FRNT\_FAN2) (see p.7, No. 12)
- (4-pin FRNT\_FAN3) (see p.7, No. 13)
- (4-pin FRNT\_FAN4) (see p.7, No. 14)
- (4-pin REAR\_FAN1) (see p.7, No. 55)

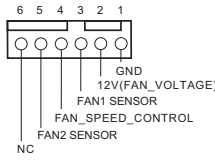

Please connect fan cables to the fan connectors and match the black wire to the ground pin. All fans support Fan Control.

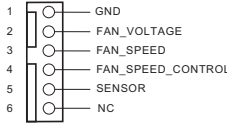

- 
- ## ATX Power Connector
- (24-pin ATXPWR1) (see p.7, No. 5)

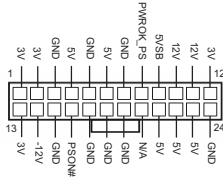

This motherboard provides a 24-pin ATX power connector. To use a 20-pin ATX power supply, please plug it along Pin 1 and Pin 13.

- 
- ## ATX 12V Power Connectors
- (8-pin ATX12V1) (see p.7, No. 4)
  - (8-pin ATX12V2) (see p.7, No. 3)

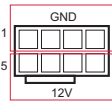

This motherboard provides two 8-pin ATX 12V power connectors.

- 
- ## TPM Header
- (17-pin TPM1) (see p.7, No. 40)

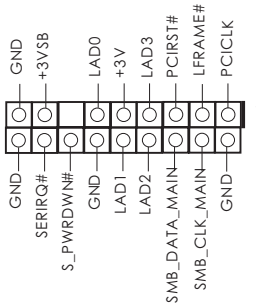

This connector supports Trusted Platform Module (TPM) system, which can securely store keys, digital certificates, passwords, and data. A TPM system also helps enhance network security, protects digital identities, and ensures platform integrity.

PSU SMBus Header  
(PSU\_SMB1)  
(see p.7, No. 6)

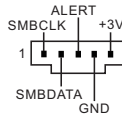

PSU SMBus monitors the status of the power supply, fan and system temperature.

Non Maskable Interrupt  
Button Header  
(NMI\_BTN1)  
(see p.7, No. 50)



Please connect a NMI device to this header.

Intelligent Platform  
Management Bus Header  
(4-pin IPMB\_1)  
(see p.7, No. 43)

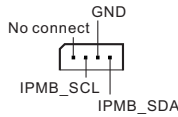

This 4-pin connector is used to provide a cabled base-board or front panel connection for value added features and 3rd-party add-in cards, such as Emergency Management cards, that provide management features using the IPMB.

Baseboard Management  
Controller SMBus Header  
(5-pin BMC\_SMB\_1)  
(see p.7, No. 44)

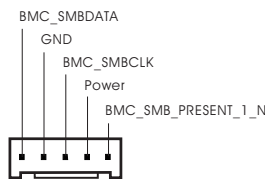

These header is used for the SM BUS devices.

Front LAN LED  
Connector  
(FRONT\_LED\_LAN1)  
(see p.7, No. 48)

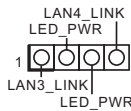

This 4-pin connector is used for the front LAN status indicator.

Serial Port Header  
(9-pin COM1)  
(see p.7, No. 46)

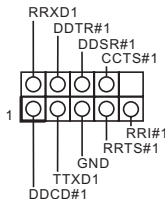

This COM header supports a serial port module.

PWM Configuration Header  
(3-pin PWM\_CFG1)  
(see p.7, No. 53)

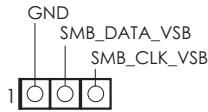

This header is used for PWM configurations.

Serial General Purpose Input/Output Headers  
(7-pin SATA\_SGPIO1)  
(see p.7, No. 33)  
(7-pin SATA\_SGPIO2)  
(see p.7, No. 49)  
(7-pin SSATA\_SGPIO1)  
(see p.7, No. 35)

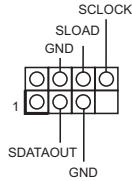

The headers support Serial Link interface for onboard SATA connections.

Front Panel Audio Header  
(9-pin HD\_AUDIO1)  
(see p.7, No. 47)

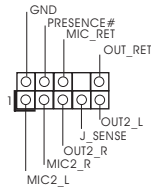

This header is for connecting audio devices to the front audio panel.



1. High Definition Audio supports Jack Sensing, but the panel wire on the chassis must support HDA to function correctly. Please follow the instructions in our manual and chassis manual to install your system.
2. If you use an AC'97 audio panel, please install it to the front panel audio header by the steps below:
  - A. Connect Mic\_IN (MIC) to MIC2\_L.
  - B. Connect Audio\_R (RIN) to OUT2\_R and Audio\_L (LIN) to OUT2\_L.
  - C. Connect Ground (GND) to Ground (GND).
  - D. MIC\_RET and OUT\_RET are for the HD audio panel only. You don't need to connect them for the AC'97 audio panel.
  - E. To activate the front mic, go to the "FrontMic" Tab in the Realtek Control panel and adjust "Recording Volume".



Virtual RAID On CPU  
Header  
(4-pin RAID\_1)  
(see p.7, No. 52)

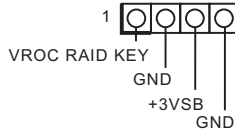

This connector supports Intel® Virtual RAID on CPU and NVME/AHCI RAID on CPU PCIE.

With the introduction of the Intel VROC product, there are three modes of operation:

SKU	HW key required	Key features
Pass-thru	Not needed	<ul style="list-style-type: none"> <li>• Pass-thru only (no RAID)</li> <li>• LED Management</li> <li>• Hot Plug Support</li> <li>• RAID 0 support for Intel Fultondale NVMe SSDs</li> </ul>
Standard	VROCSTANMOD	<ul style="list-style-type: none"> <li>• Pass-thru SKU features</li> <li>• RAID 0, 1, 10</li> </ul>
Premium	VROCPREMMOD	<ul style="list-style-type: none"> <li>• Standard SKU features</li> <li>• RAID 5</li> </ul>
ISS	VROCISSDMOD	<ul style="list-style-type: none"> <li>• RAID 5 Write Hole Closure</li> </ul>

\*Only Intel SSDs are supported.

\*For further details on VROC, please refer to the official information released by Intel.

---

## 2.8 Driver Installation Guide

To install the drivers to your system, please insert the support CD to your optical drive first. Then, the drivers compatible to your system can be auto-detected and listed on the support CD driver page. Please follow the order from top to bottom to install those required drivers. Therefore, the drivers you install can work properly.

## 2.9 Dual LAN and Teaming Operation Guide

Dual LAN with Teaming enabled on this motherboard allows two single connections to act as one single connection for twice the transmission bandwidth, making data transmission more effective and improving the quality of transmission of distant images. Fault tolerance on the dual LAN network prevents network downtime by transferring the workload from a failed port to a working port.



*The speed of transmission is subject to the actual network environment or status even with Teaming enabled.*

Before setting up Teaming, please make sure whether your Switch (or Router) supports Teaming (IEEE 802.3ad Link Aggregation). You can specify a preferred adapter in Intel PROSet. Under normal conditions, the Primary adapter handles all non-TCP/IP traffic. The Secondary adapter will receive fallback traffic if the primary fails. If the Preferred Primary adapter fails, but is later restored to an active status, control is automatically switched back to the Preferred Primary adapter.

### **Step 1**

From **Device Manager**, open the properties of a team.

### **Step 2**

Click the **Settings** tab.

### **Step 3**

Click the **Modify Team** button.

### **Step 4**

Select the adapter you want to be the primary adapter and click the **Set Primary** button.

If you do not specify a preferred primary adapter, the software will choose an adapter of the highest capability (model and speed) to act as the default primary. If a failover occurs, another adapter becomes the primary. The adapter will, however, rejoin the team as a non-primary.

## 2.10 M.2\_SSD (NGFF) Module Installation Guide

The M.2, also known as the Next Generation Form Factor (NGFF), is a small size and versatile card edge connector that aims to replace mPCIe and mSATA. The M.2\_SSD (NGFF) Socket 3 can accommodate either a M.2 SATA3 6.0 Gb/s module or a M.2 PCI Express module up to Gen3 x4 (32 Gb/s).

### Installing the M.2\_SSD (NGFF) Module

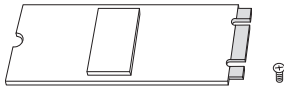

#### Step 1

Prepare a M.2\_SSD (NGFF) module and the screw.

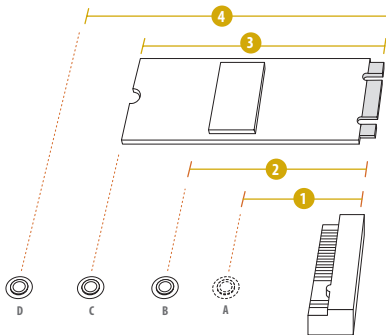

#### Step 2

Depending on the PCB type and length of your M.2\_SSD (NGFF) module, find the corresponding nut location to be used.

No.	1	2	3	4
Nut Location	A	B	C	D
PCB Length	3cm	4.2cm	6cm	8cm
Module Type	Type2230	Type 2242	Type2260	Type 2280

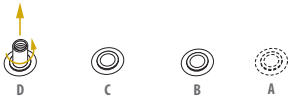
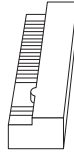
**Step 3**

Move the standoff based on the module type and length. The standoff is placed at the nut location D by default. Skip Step 3 and 4 and go straight to Step 5 if you are going to use the default nut. Otherwise, release the standoff by hand.

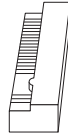
**Step 4**

Peel off the yellow protective film on the nut to be used. Hand tighten the standoff into the desired nut location on the motherboard.

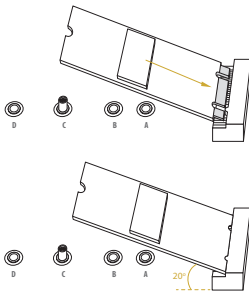
**Step 5**

Gently insert the M.2 (NGFF) SSD module into the M.2 slot. Please be aware that the M.2 (NGFF) SSD module only fits in one orientation.

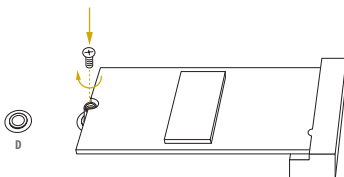
**Step 6**

Tighten the screw with a screwdriver to secure the module into place. Please do not overtighten the screw as this might damage the module.

For the latest updates of M.2\_SSD (NFGG) module support list, please visit our website for details: <http://www.asrockrack.com>

# Chapter 3 UEFI Setup Utility

## 3.1 Introduction

This section explains how to use the UEFI SETUP UTILITY to configure your system. The UEFI chip on the motherboard stores the UEFI SETUP UTILITY. You may run the UEFI SETUP UTILITY when you start up the computer. Please press <F2> or <Del> during the Power-On-Self-Test (POST) to enter the UEFI SETUP UTILITY; otherwise, POST will continue with its test routines.

If you wish to enter the UEFI SETUP UTILITY after POST, restart the system by pressing <Ctrl> + <Alt> + <Delete>, or by pressing the reset button on the system chassis. You may also restart by turning the system off and then back on.



*Because the UEFI software is constantly being updated, the following UEFI setup screens and descriptions are for reference purpose only, and they may not exactly match what you see on your screen.*

### 3.1.1 UEFI Menu Bar

The top of the screen has a menu bar with the following selections:

Item	Description
Main	To set up the system time/date information
Advanced	To set up the advanced UEFI features
Server Mgmt	To manage the server
Security	To set up the security features
Boot	To set up the default system device to locate and load the Operating System
Event Logs	For event log configuration
Exit	To exit the current screen or the UEFI SETUP UTILITY

Use <←> key or <→> key to choose among the selections on the menu bar, and then press <Enter> to get into the sub screen.

### 3.1.2 Navigation Keys

Please check the following table for the function description of each navigation key.

Navigation Key(s)	Function Description
← / →	Moves cursor left or right to select Screens
↑ / ↓	Moves cursor up or down to select items
+ / -	To change option for the selected items
<Tab>	Switch to next function
<Enter>	To bring up the selected screen
<PGUP>	Go to the previous page
<PGDN>	Go to the next page
<HOME>	Go to the top of the screen
<END>	Go to the bottom of the screen
<F1>	To display the General Help Screen
<F7>	Discard changes and exit the UEFI SETUP UTILITY
<F9>	Load optimal default values for all the settings
<F10>	Save changes and exit the UEFI SETUP UTILITY
<F12>	Print screen
<ESC>	Jump to the Exit Screen or exit the current screen

## 3.2 Main Screen

Once you enter the UEFI SETUP UTILITY, the Main screen will appear and display the system overview. The Main screen provides system overview information and allows you to set the system time and date.

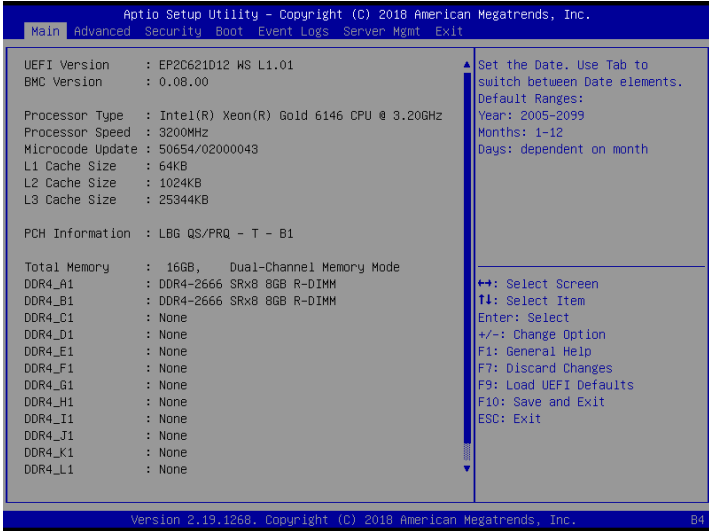



### 3.3 Advanced Screen

In this section, you may set the configurations for the following items: CPU Configuration, DRAM Configuration, Chipset Configuration, Storage Configuration, ACPI Configuration, USB Configuration, Super IO Configuration, Serial Port Console Redirection, H/W Monitor, Runtime Error Logging, Intel SPS Configuration, Overclocking, Intel(R) VMD Technology, Intel(R) Virtual RAID on CPU and Instant Flash.

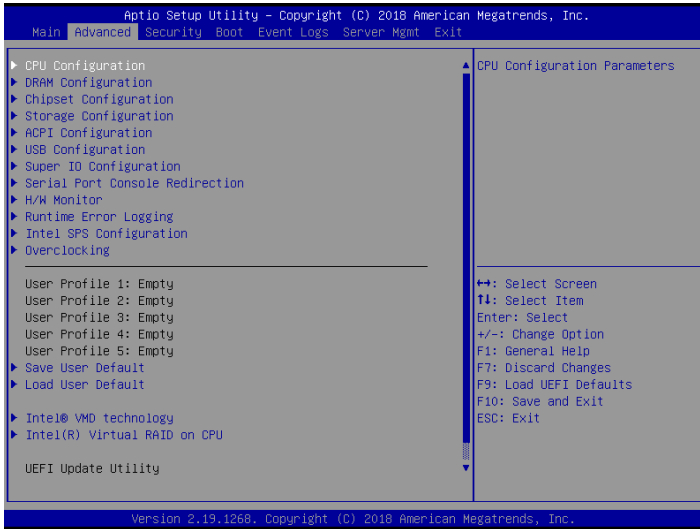

Setting wrong values in this section may cause the system to malfunction.

### 3.3.1 CPU Configuration

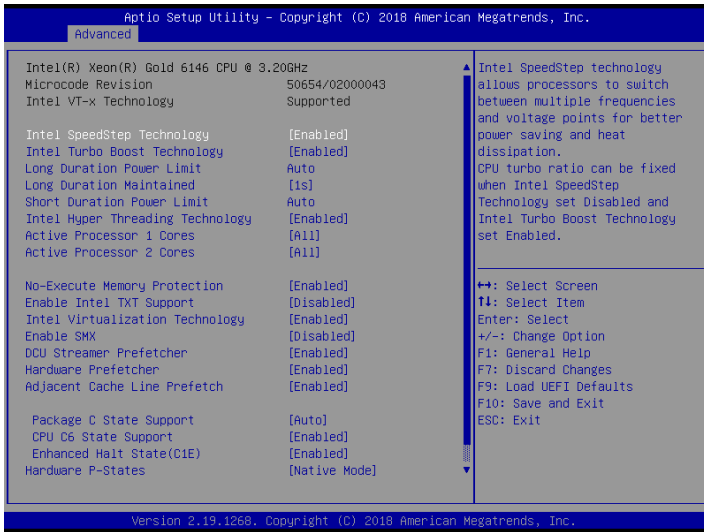

#### Intel SpeedStep Technology

Intel SpeedStep technology allows processors to switch between multiple frequencies and voltage points for better power saving and heat dissipation. CPU turbo ratio can be fixed when Intel SpeedStep Technology set Disabled and Intel Turbo Boost Technology set Enabled.



*Please note that enabling this function may reduce CPU voltage and lead to system stability or compatibility issues with some power supplies. Please set this item to [Disabled] if above issues occur.*

#### Intel Turbo Boost Technology

Intel Turbo Boost Technology enables the processor to run above its base operating frequency when the operating system requests the highest performance state.

#### Long Duration Power Limit

Configure Package Power Limit 1 in watts. When the limit is exceeded, the CPU ratio will be lowered after a period of time. A lower limit can protect the CPU and save power, while a higher limit may improve performance.

#### Long Duration Maintained

Configure the period of time until the CPU ratio is lowered when the Long Duration Power

Limit is exceeded.

### Short Duration Power Limit

Configure Package Power Limit 2 in watts. When the limit is exceeded, the CPU ratio will be lowered immediately. A lower limit can protect the CPU and save power, while a higher limit may improve performance.

### Intel Hyper Threading Technology

Intel Hyper Threading Technology allows multiple threads to run on each core, so that the overall performance on threaded software is improved.

### Active Processor 1 Cores

Select the number of cores to enable in each processor package.

### Active Processor 2 Cores

Select the number of cores to enable in each processor package.

### No-Execute Memory Protection

Processors with No-Execution Memory Protection Technology may prevent certain classes of malicious buffer overflow attacks.

### Enable Intel TXT Support

Enables Intel Trusted Execution Technology Configuration.

### Intel Virtualization Technology

Intel Virtualization Technology allows a platform to run multiple operating systems and applications in independent partitions, so that one computer system can function as multiple virtual systems.

### Enable SMX

Use this item to enable Safer Mode Extensions.

### DCU Streamer Prefetcher

DCU streamer prefetcher is an L1 data cache prefetcher (MSR 1A4h [2]).

### Hardware Prefetcher

Automatically prefetch data and code for the processor. Enable for better performance.

### Adjacent Cache Line Prefetch

Automatically prefetch the subsequent cache line while retrieving the currently requested cache line. Enable for better performance.

## Package C State Support

Enable CPU, PCIe, Memory, Graphics C State Support for power saving.

## CPU C6 State Support

Enable C6 deep sleep state for lower power consumption.

## Enhanced Halt State(C1E)

Enable Enhanced Halt State (C1E) for lower power consumption.

## Hardware P-States

Disable: Hardware chooses a P-state based on OS Request (Legacy P-States)

Native Mode: Hardware chooses a P-state based on OS guidance

Out of Band Mode: Hardware autonomously chooses a P-state (no OS guidance)

## AES-NI

Use this item to enable or disable AES-NI support.

## CPU Thermal Throttling

Enable CPU internal thermal control mechanisms to keep the CPU from overheating.

### 3.3.2 DRAM Configuration

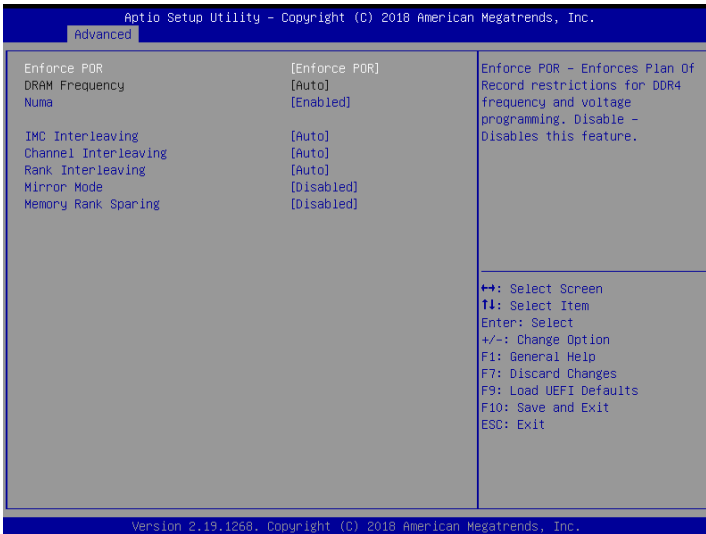

#### Enforce POR

Enable to enforce POR restrictions for DDR4 frequency and voltage programming.

#### DRAM Frequency

If [Auto] is selected, the motherboard will detect the memory module(s) inserted and assign the appropriate frequency automatically.

#### Numa

Use this item to enable or disable Non Uniform Memory Access (NUMA).

#### IMC Interleaving

Select IMC Interleaving settings.

#### Channel Interleaving

Select to configure Channel Interleaving settings.

#### Rank Interleaving

Select to configure Rank Interleaving settings.

#### Mirror Mode

Mirror Mode will set entire 1LM/2LM memory in system to be mirrored, consequently reducing the memory capacity by half. Mirror Enable will disable XPT Prefetch.

---

## Memory Rank Sparing

Enable or disable Memory Rank Sparing.

### 3.3.3 Chipset Configuration

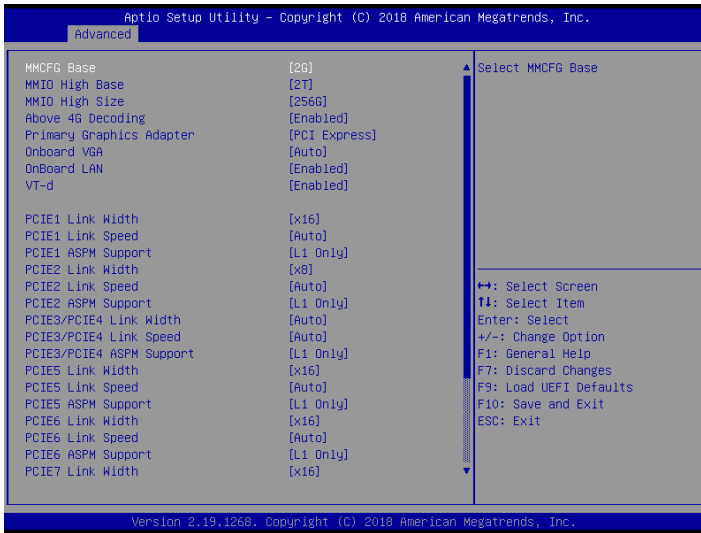

#### MMCFG Base

Use this item to select MMCFG Base.

#### MMIO High Base

Use this item to select MMIO High Base.

#### MMIO High Size

Use this item to select MMIO High Size.

#### Above 4G Decoding

Enable or disable 64bit capable Devices to be decoded in Above 4G Address Space (only if the system supports 64 bit PCI decoding).

#### Primary Graphics Adapter

If PCI Express graphics card is installed on the motherboard, you may use this option to select PCI Express or Onboard VGA as the primary graphics adapter.

*\*If no PCI Express graphics card is installed, [Onboard VGA] is the default graphics adapter.*

#### Onboard VGA

Use this to enable or disable the Onboard VGA function. The default value is [Auto].

*\*This item is not available when the Primary Graphic Adapter is set to [Onboard VGA].*

## OnBoard LAN

Enabled/Disabled OnBoard LAN.

## VT-d

Intel Virtualization Technology for Directed I/O helps your virtual machine monitor better utilize hardware by improving application compatibility and reliability, and providing additional levels of manageability, security, isolation, and I/O performance.

## PCIE1 Link Width

This allows you to select PCIE Link Width.

## PCIE1 Link Speed

This allows you to select PCIE Link Speed.

## PCIE1 ASPM Support

This option enables or disables the ASPM support for all CPU downstream devices.

## PCIE2 Link Width

This allows you to select PCIE Link Width.

## PCIE2 Link Speed

This allows you to select PCIE Link Speed.

## PCIE2 ASPM Support

This option enables or disables the ASPM support for all CPU downstream devices.

## PCIE3/PCIE4 Link Width

This allows you to select PCIE Link Width.

## PCIE3/PCIE4 Link Speed

This allows you to select PCIE Link Speed.

## PCIE3/PCIE4 ASPM Support

This option enables or disables the ASPM support for all CPU downstream devices.

## PCIE5 Link Width

This allows you to select PCIE Link Width.

## PCIE5 Link Speed

This allows you to select PCIE Link Speed.



### PCIe5 ASPM Support

This option enables or disables the ASPM support for all CPU downstream devices.

### PCIe6 Link Width

This allows you to select PCIe Link Width.

### PCIe6 Link Speed

This allows you to select PCIe Link Speed.

### PCIe6 ASPM Support

This option enables or disables the ASPM support for all CPU downstream devices.

### PCIe7 Link Width

This allows you to select PCIe Link Width.

### PCIe7 Link Speed

This allows you to select PCIe Link Speed.

### PCIe7 ASPM Support

This option enables or disables the ASPM support for all CPU downstream devices.

### SR-IOV Support

If system has SR-IOV capable PCIe Devices, this option Enables or Disables Single Root IO Virtualization Support.

### Restore AC Power Loss

This allows you to set the power state after a power failure. If [Power Off] is selected, the power will remain off when the power recovers. If [Power On] is selected, the system will start to boot up when the power recovers.

### Restore AC Power Current State

This allows you to restore AC Power Current State.

### Onboard HD Audio

Auto/enable/disable onboard HD audio. Set to Auto to enable onboard HD audio and automatically disable it when a sound card is installed.

### Front Panel

Use this item to select Front Panel Type.

## 3.3.4 Storage Configuration

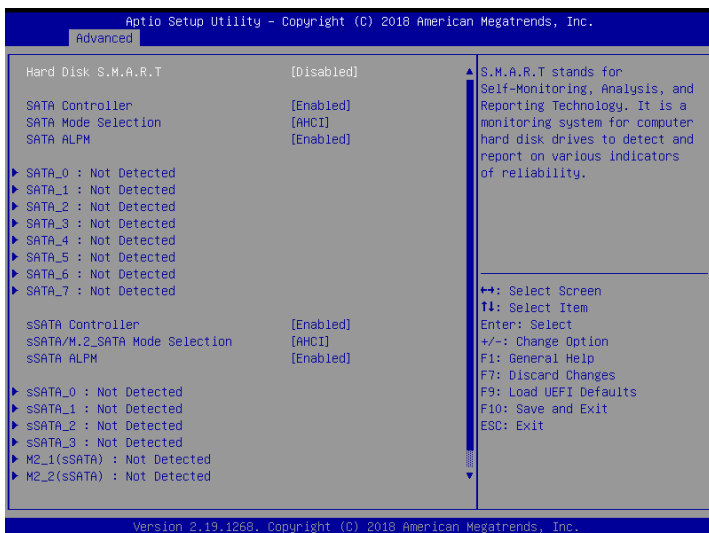

### Hard Disk S.M.A.R.T.

Use this item to enable or disable the S.M.A.R.T. (Self-Monitoring, Analysis, and Reporting Technology) feature. Configuration options: [Disabled] and [Enabled].

### SATA Controller

Use this item to enable or disable SATA Controllers.

### SATA Mode Selection

Identify the SATA port is connected to Solid State Drive or Hard Disk Drive. Press <Ctrl+I> to enter RAID ROM during UEFI POST process.

### SATA ALPM

Use this item to enable or disable SALP.

### sSATA Controller

Use this item to enable or disable SATA Controllers.

### sSATA/M.2\_SATA Mode Selection

Identify the sSATA/M.2\_SATA port is connected to Solid State Drive or Hard Disk Drive. Press <Ctrl+I> to enter RAID ROM during UEFI POST process.

## sSATA ALPM

Use this item to enable or disable SALP.

### 3.3.5 ACPI Configuration

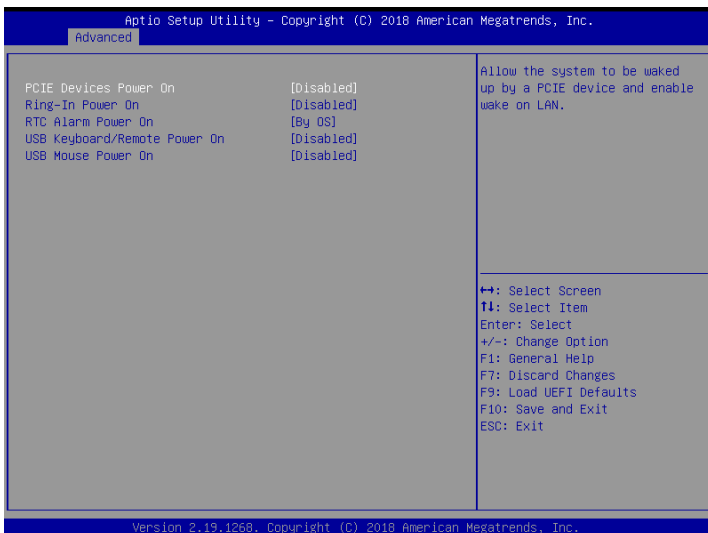

#### PCIe Devices Power On

Use this item to enable or disable PCIe devices to turn on the system from the power-soff mode.

#### Ring-In Power On

Use this item to enable or disable Ring-In signals to turn on the system from the powersoftoff mode.

#### RTC Alarm Power On

Use this item to enable or disable RTC (Real Time Clock) to power on the system.

#### USB Keyboard/Remote Power On

Allow the system to be waked up by an USB keyboard or remote controller.

#### USB Mouse Power On

Allow the system to be waked up by an USB mouse.

### 3.3.6 USB Configuration

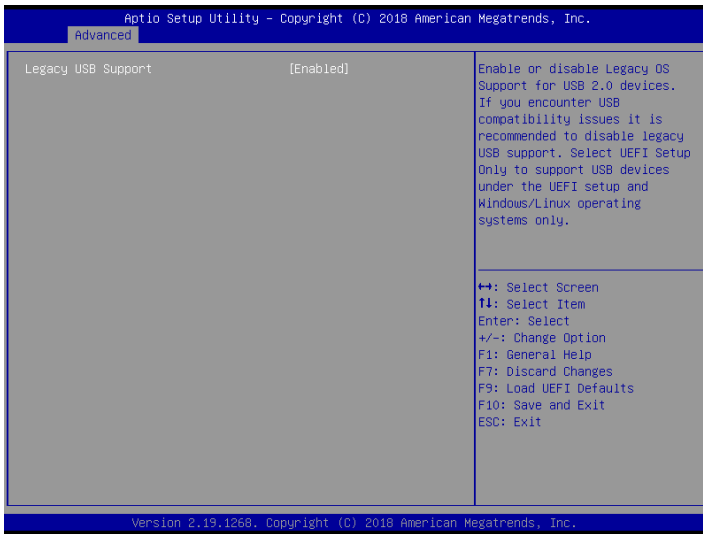

#### Legacy USB Support

Use this option to enable or disable legacy support for USB devices. The default value is [Enabled].

## 3.3.7 Super IO Configuration

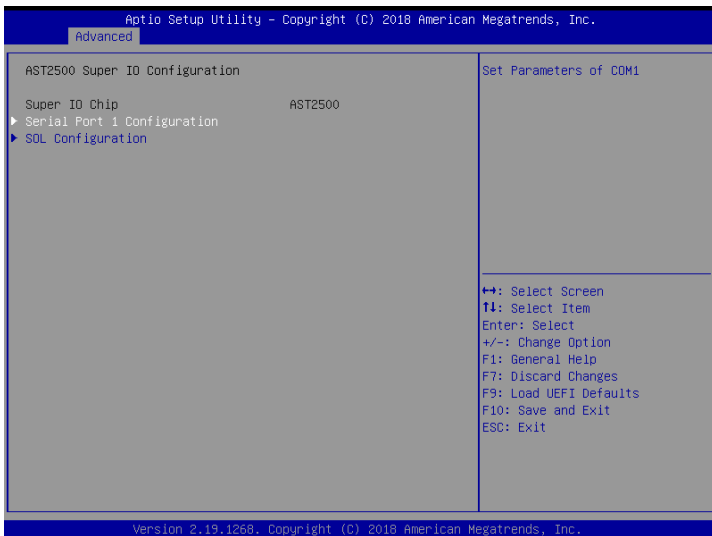

### Serial Port 1 Configuration

Use this item to set parameters of Serial Port 1 (COM1).

### Serial Port

Use this item to enable or disable the serial port.

### Change Settings

Use this item to select an optimal setting for Super IO device.

### SOL Configuration

Use this item to set SOL configuration.

### SOL Port

Use this item to enable or disable the SOL port.

### Change Settings

Use this item to select an optimal setting for Super IO device.

### 3.3.8 Serial Port Console Redirection

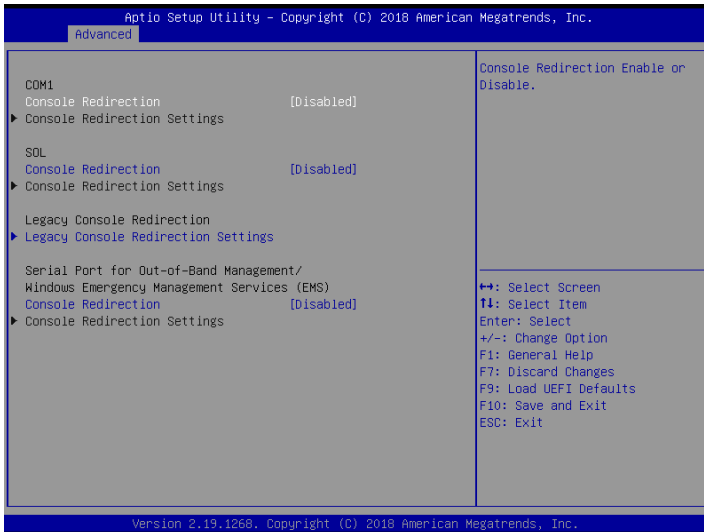

#### COM1 / SOL

#### Console Redirection

Use this option to enable or disable Console Redirection. If this item is set to Enabled, you can select a COM Port to be used for Console Redirection.

#### Console Redirection Settings

Use this option to configure Console Redirection Settings, and specify how your computer and the host computer to which you are connected exchange information. Both computers should have the same or compatible settings.

#### Terminal Type

Use this item to select the preferred terminal emulation type for out-of-band management. It is recommended to select [VT-UTF8].

Option	Description
VT100	ASCII character set
VT100+	Extended VT100 that supports color and function keys
VT-UTF8	UTF8 encoding is used to map Unicode chars onto 1 or more bytes
ANSI	Extended ASCII character set

### **Bits Per Second**

Use this item to select the serial port transmission speed. The speed used in the host computer and the client computer must be the same. Long or noisy lines may require lower transmission speed. The options include [9600], [19200], [38400], [57600] and [115200].

### **Data Bits**

Use this item to set the data transmission size. The options include [7] and [8] (Bits).

### **Parity**

Use this item to select the parity bit. The options include [None], [Even], [Odd], [Mark] and [Space].

### **Stop Bits**

The item indicates the end of a serial data packet. The standard setting is [1] Stop Bit. Select [2] Stop Bits for slower devices.

### **Flow Control**

Use this item to set the flow control to prevent data loss from buffer overflow. When sending data, if the receiving buffers are full, a "stop" signal can be sent to stop the data flow. Once the buffers are empty, a "start" signal can be sent to restart the flow. Hardware flow uses two wires to send start/stop signals. The options include [None] and [Hardware RTS/CTS].

### **VT-UTF8 Combo Key Support**

Use this item to enable or disable the VT-UTF8 Combo Key Support for ANSI/VT100 terminals.

### **Recorder Mode**

Use this item to enable or disable Recorder Mode to capture terminal data and send it as text messages.

### **Resolution 100x31**

Use this item to enable or disable extended terminal resolution support.

### **Legacy OS Redirection Resolution**

Use this item to select the number of rows and columns used in legacy OS redirection.

### **Putty Keypad**

Use this item to select Function Key and Keypad on Putty.

### **Redirection After BIOS POST**

If the [LoadBooster] is selected, legacy console redirection is disabled before booting to legacy OS. If [Always Enabled] is selected, legacy console redirection is enabled for legacy OS. The default value is [Always Enabled].

## **Legacy Console Redirection**

### **Legacy Console Redirection Settings**

Use this option to configure Legacy Console Redirection Settings, and specify how your



computer and the host computer to which you are connected exchange information.

### Legacy Serial Redirection Port

Use this item to select a COM port to display redirection of Legacy OS and Legacy OPRM Messages.

## Serial Port for Out-of-Band Management/Windows Emergency Management Services (EMS)

### Console Redirection

Use this option to enable or disable Console Redirection. If this item is set to Enabled, you can select a COM Port to be used for Console Redirection.

### Console Redirection Settings

Use this option to configure Console Redirection Settings, and specify how your computer and the host computer to which you are connected exchange information.

### Out-of-Band Mgmt Port

Microsoft Windows Emergency Management Services (EMS) allows for remote management of a Windows Server OS through a serial port.

### Terminal Type

Use this item to select the preferred terminal emulation type for out-of-band management. It is recommended to select [VT-UTF8].

Option	Description
VT100	ASCII character set
VT100+	Extended VT100 that supports color and function keys
VT-UTF8	UTF8 encoding is used to map Unicode chars onto 1 or more bytes
ANSI	Extended ASCII character set

### Bits Per Second

Use this item to select the serial port transmission speed. The speed used in the host computer and the client computer must be the same. Long or noisy lines may require lower transmission speed. The options include [9600], [19200], [57600] and [115200].

### Flow Control

Use this item to set the flow control to prevent data loss from buffer overflow. When sending data, if the receiving buffers are full, a "stop" signal can be sent to stop the data flow. Once the buffers are empty, a "start" signal can be sent to restart the flow. Hardware flow uses two wires to send start/stop signals. The options include [None], [Hardware RTS/CTS], and [Software Xon/Xoff].

### Data Bits

### Parity

### Stop Bits

### 3.3.9 H/W Monitor

In this section, it allows you to monitor the status of the hardware on your system, including the parameters of the CPU temperature, motherboard temperature, CPU fan speed, chassis fan speed, and the critical voltage.

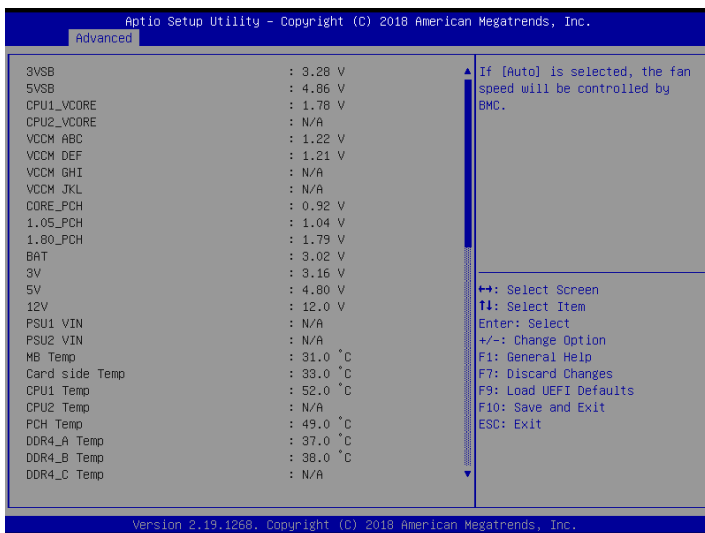

#### Fan Control

If [Auto] is selected, the fan speed will be controlled by BMC.

If [Manual] is selected, configure the items below.

#### CPU1\_FAN1

This allows you to set the CPU1 fan1's speed. The default value is [Smart Fan].

#### CPU2\_FAN1

This allows you to set the CPU2 fan1's speed. The default value is [Smart Fan].

#### REAR\_FAN1

This allows you to set the Rear fan1's speed. The default value is [Smart Fan].

#### FRNT\_FAN1

This allows you to set the Front fan1's speed. The default value is [Smart Fan].

#### FRNT\_FAN2

This allows you to set the Front fan2's speed. The default value is [Smart Fan].

**FRNT\_FAN3**

This allows you to set the Front fan3's speed. The default value is [Smart Fan].

**FRNT\_FAN4**

This allows you to set the Front fan4's speed. The default value is [Smart Fan].

**Smart Fan Control**

This allows you to set the Smart fan's level speed.

**Smart Fan Duty Control**

Smart Fan Duty x (x means 1 to 11 stage)

This allows you to set duty cycle for each stage.

**Smart Fan Temp Control**

Smart Fan Temp x (x means 1 to 11 stage)

This allows you to set temperature for each stage.

**Watch Dog Timer**

This allows you to enable or disable the Watch Dog Timer. The default value is [Disabled].

## 3.3.10 Runtime Error Logging

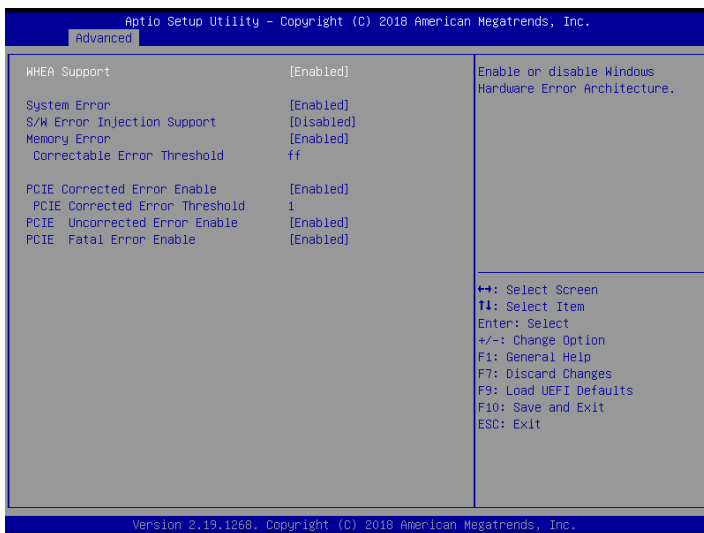

### WHEA Support

Use this item to enable or disable Windows Hardware Error Architecture.

### System Error

Use this item to enable or disable System Error feature. When it is set to [Enabled], you can configure Memory Error and PCIE Error log features.

### S/W Error Injection Support

When it is set to [Enabled], S/W Error Injection is supported by unlocking MSR Ox790.

### Memory Error

Memory enabling and logging setup option.

### Correctable Error Threshold

Correctable Error Threshold (0 - 0x7FFF) used for sparing, tagging, and leaky bucket.

### PCIE Corrected Error Enable

Use this item to enable or disable PCIE Correctable errors.

### PCIE Corrected Error Threshold

PCIE Correctable Error Threshold (0x01-0xFF) used for sparing, tagging, and leaky bucket.

### PCIE Uncorrected Error Enable

Use this item to enable or disable PCIe Uncorrectable errors.

### PCIE Fatal Error Enable

Use this item to enable or disable PCIe Ftal errors.

### 3.3.11 Intel SPS Configuration

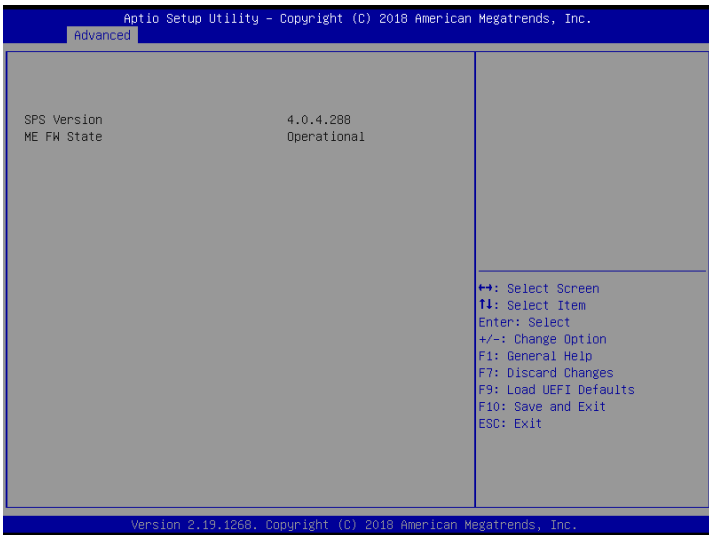

ME Subsystem screen displays the Intel ME Subsystem Configuration information, such as Operational Firmware Version and Firmware State.

## 3.3.12 Overclocking

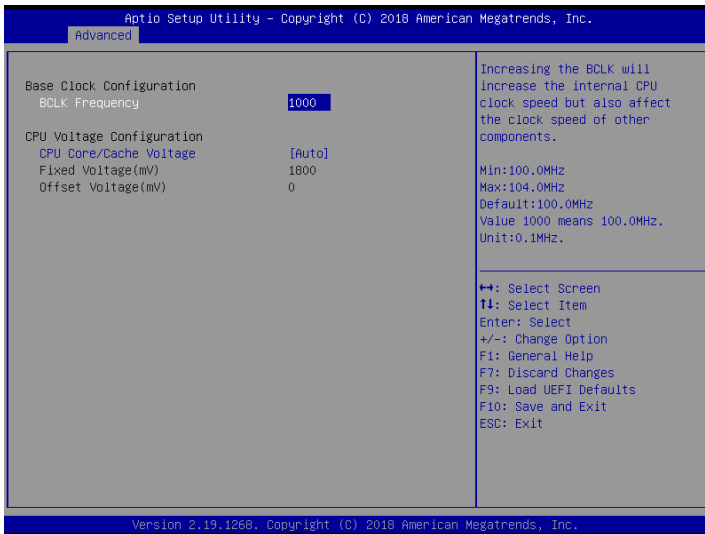

### Base Clock Configuration

#### BCLK Frequency

Increasing the BCLK will increase the internal CPU clock speed of other components.

Min: 100.0MHz

Max:104.0MHz

Default:100.0MHz

Value 1000 means 100.0MHz

Unit: 0.1MHz

### CPU Voltage Configuration

#### CPU Core/Cache Voltage

Input voltage for the processor by the external voltage regulator.

#### Fixed Voltage(mV)

System may be damaged or reduce its life cycle when overvoltage.

Min:1800mV

Max:2000mV

Default:1800mV

Unit:1mV

## Offset Voltage(mV)

System may be damaged or reduce its life cycle when overvoltage.

Min:0mV

Max:200mV

Default:0mV

Unit:1mV



### 3.3.13 Intel® VMD technology

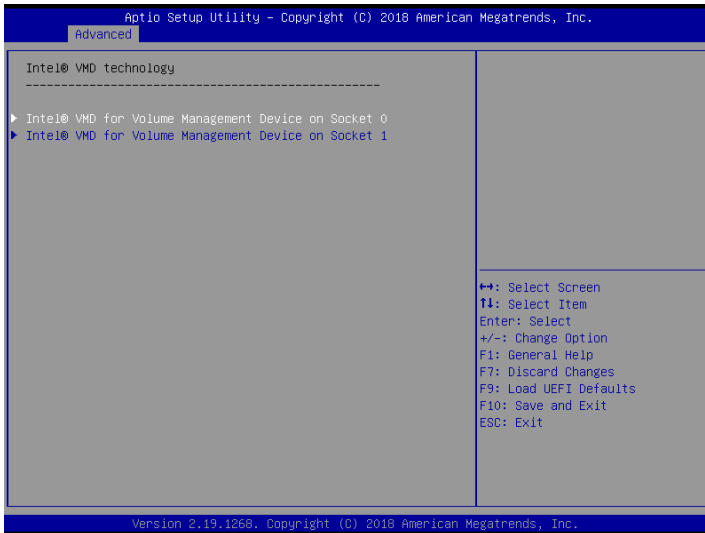

Press <Enter> to bring up the Intel® VMD for Volume Management Device Configuration menu.

Intel® VMD for Volume Management Device on Socket0 /

Intel® VMD for Volume Management Device on Socket1

Intel® VMD for Volume Management Device Technology

Use this item to enable or disable Intel(R) Volume Management Device Technology in this Stack.

When [Enabled], users are allowed to configure the options below.

**VMD port 1A**

Use this item to enable or disable Intel(R) Volume Management Device Technology on specific root port.

**VMD port 1B**

Use this item to enable or disable Intel(R) Volume Management Device Technology on specific root port.

**VMD port 1D**

Use this item to enable or disable Intel(R) Volume Management Device Technology on

specific root port.

### Hot Plug Capable

Use this item to enable or disable Hot Plug for PCIe Root Ports 1A-1B,1D.

### Intel® VMD for Volume Management Device Technology

Use this item to enable or disable Intel(R) Volume Management Device Technology in this Stack.

When [Enabled], users are allowed to configure the options below.

#### VMD port 2A

Use this item to enable or disable Intel(R) Volume Management Device Technology on specific root port.

#### VMD port 2B

Use this item to enable or disable Intel(R) Volume Management Device Technology on specific root port.

#### VMD port 2C

Use this item to enable or disable Intel(R) Volume Management Device Technology on specific root port.

#### VMD port 2D

Use this item to enable or disable Intel(R) Volume Management Device Technology on specific root port.

### Hot Plug Capable

Use this item to enable or disable Hot Plug for PCIe Root Ports 2A-2D.

### Intel® VMD for Volume Management Device Technology

Use this item to enable or disable Intel(R) Volume Management Device Technology in this Stack.

When [Enabled], users are allowed to configure the options below.

#### VMD port 3A

Use this item to enable or disable Intel(R) Volume Management Device Technology on specific root port.

#### VMD port 3B

Use this item to enable or disable Intel(R) Volume Management Device Technology on specific root port.

### VMD port 3C

Use this item to enable or disable Intel(R) Volume Management Device Technology on specific root port.

### VMD port 3D

Use this item to enable or disable Intel(R) Volume Management Device Technology on specific root port.

### Hot Plug Capable

Use this item to enable or disable Hot Plug for PCIe Root Ports 3A-3D.

### Intel® VMD for Volume Management Device on Socket1

### Intel® VMD for Volume Management Device Technology

Use this item to enable or disable Intel(R) Volume Management Device Technology in this Stack.

When [Enabled], users are allowed to configure the options below.

### VMD port 1A

Use this item to enable or disable Intel(R) Volume Management Device Technology on specific root port.

### VMD port 1B

Use this item to enable or disable Intel(R) Volume Management Device Technology on specific root port.

### VMD port 1C

Use this item to enable or disable Intel(R) Volume Management Device Technology on specific root port.

### VMD port 1D

Use this item to enable or disable Intel(R) Volume Management Device Technology on specific root port.

### Hot Plug Capable

Use this item to enable or disable Hot Plug for PCIe Root Ports 1A-1D.

### Intel® VMD for Volume Management Device Technology

Use this item to enable or disable Intel(R) Volume Management Device Technology in this Stack.

When [Enabled], users are allowed to configure the options below.

## VMD port 2A

Use this item to enable or disable Intel(R) Volume Management Device Technology on specific root port.

## VMD port 2B

Use this item to enable or disable Intel(R) Volume Management Device Technology on specific root port.

## VMD port 2C

Use this item to enable or disable Intel(R) Volume Management Device Technology on specific root port.

## VMD port 2D

Use this item to enable or disable Intel(R) Volume Management Device Technology on specific root port.

## Hot Plug Capable

Use this item to enable or disable Hot Plug for PCIe Root Ports 2A-2D.

## Intel® VMD for Volume Management Device Technology

Use this item to enable or disable Intel(R) Volume Management Device Technology in this Stack.

When [Enabled], users are allowed to configure the options below.

## VMD port 3A

Use this item to enable or disable Intel(R) Volume Management Device Technology on specific root port.

## VMD port 3B

Use this item to enable or disable Intel(R) Volume Management Device Technology on specific root port.

## VMD port 3C

Use this item to enable or disable Intel(R) Volume Management Device Technology on specific root port.

## VMD port 3D

Use this item to enable or disable Intel(R) Volume Management Device Technology on specific root port.

## Hot Plug Capable

Use this item to enable or disable Hot Plug for PCIe Root Ports 3A-3D.

### 3.3.14 Intel® Virtual RAID on CPU

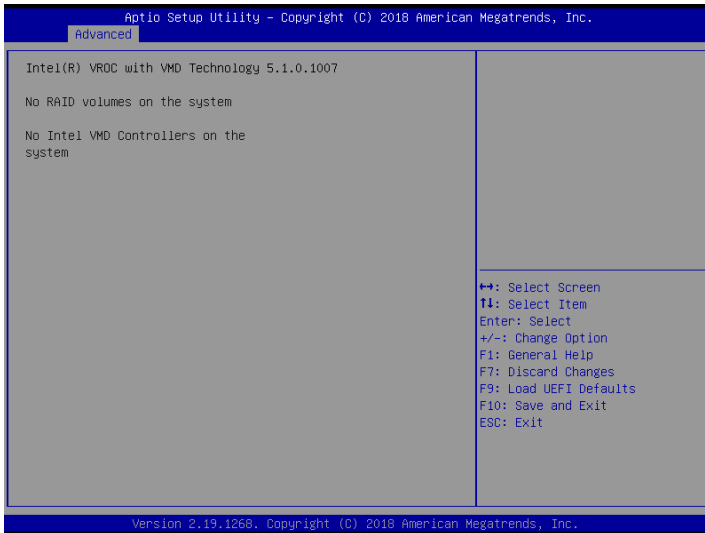

**Intel VROC Managed Volumes** (Available after the RAID has been created.)

Select to see more information about the RAID Volume.

**All Intel VMD Controllers**

Select to see more information about the Intel VMD Controllers.

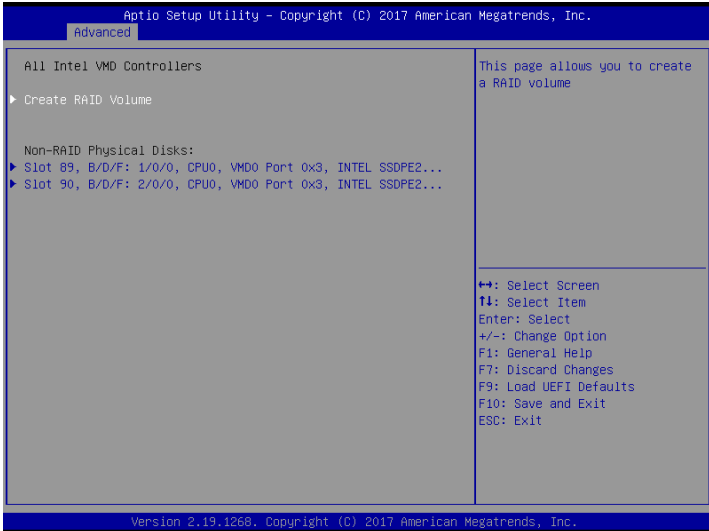

## Create RAID Volume

This page allows you to create a RAID volume.

**Non-RAID Physical Disks** (Available when no RAID is created.)

Select to see more information about the disk.

**RAID Volumes** (Available after the RAID has been created.)

Select to see more information about the RAID Volume.

## Volume Actions

### Delete

Select to delete the created RAID.

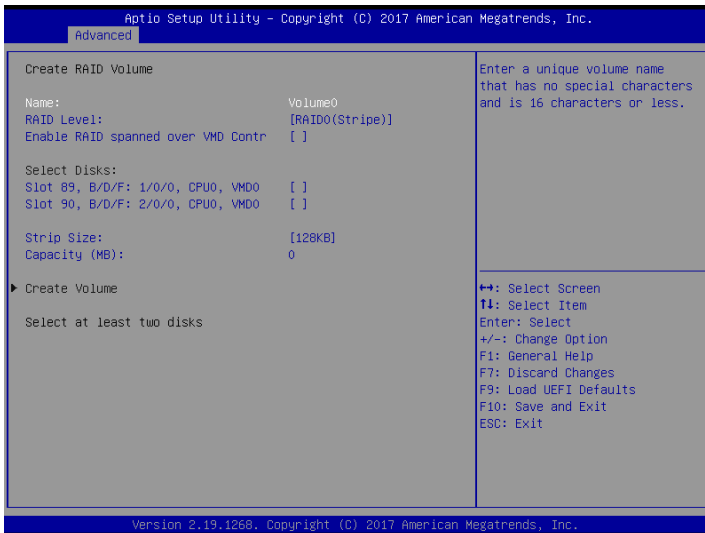

### Name

Enter an unique volume name that has no special characters and is 16 charaters or less.

### RAID Level

Select RAID Level.

### Enable RAID spanned over VMD Controllers

Select [X] to enable RAID spanned over VMD Controllers.

### Select Disks

Select [X] to select disks.

### Strip Size

Select strip size.

### Capacity (MB)

Determine the capacity in MB.

### Create Volume

Select to start creating RAID immediately. (Available after selecting at least two disks.)

### 3.3.15 Instant Flash

Instant Flash is a UEFI flash utility embedded in Flash ROM. This convenient UEFI update tool allows you to update system UEFI without entering operating systems first like MS-DOS or Windows. Just save the new UEFI file to your USB flash drive, floppy disk or hard drive and launch this tool, then you can update your UEFI only in a few clicks without preparing an additional floppy diskette or other complicated flash utility. Please be noted that the USB flash drive or hard drive must use FAT32/16/12 file system. If you execute Instant Flash utility, the utility will show the UEFI files and their respective information. Select the proper UEFI file to update your UEFI, and reboot your system after the UEFI update process is completed.



## 3.4 Security

In this section, you may set or change the supervisor/user password for the system. For the user password, you may also clear it.

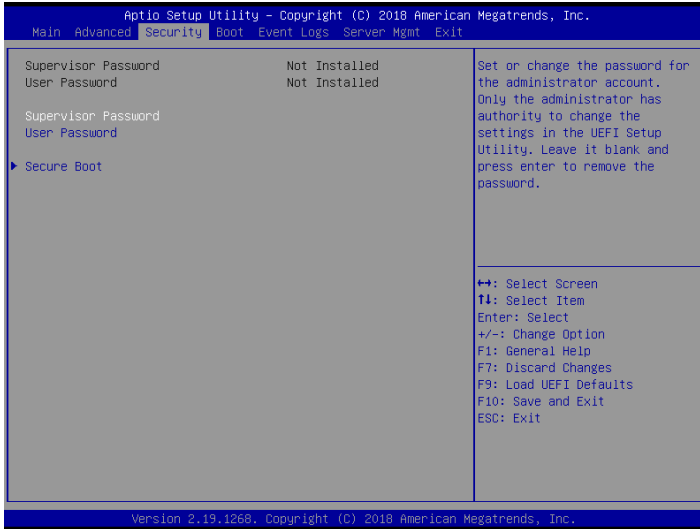

### Supervisor Password

Set or change the password for the administrator account. Only the administrator has authority to change the settings in the UEFI Setup Utility. Leave it blank and press enter to remove the password.

### User Password

Set or change the password for the user account. Users are unable to change the settings in the UEFI Setup Utility. Leave it blank and press enter to remove the password.

### Secure Boot

Use this to enable or disable Secure Boot Control. The default value is [Disabled].

### Secure Boot Mode

Enable to support Windows 8 or later versions Secure Boot.

## 3.4.1 Key Management

In this section, expert users can modify Secure Boot Policy variables without full authentication.

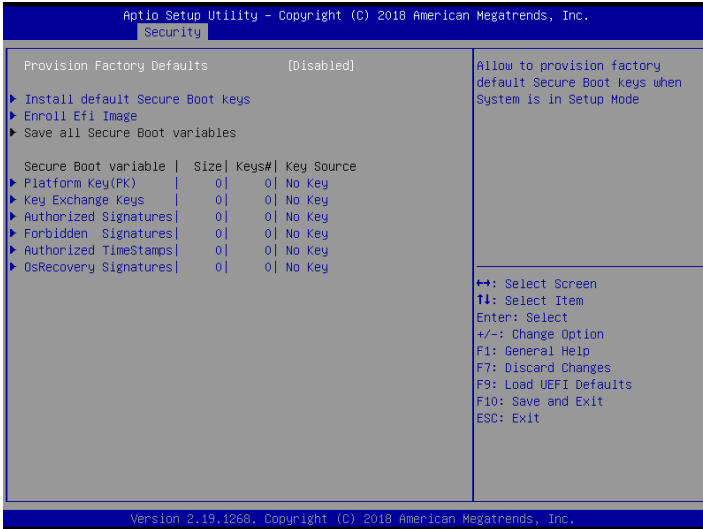

### Provision Factory Defaults

Allow to provision factory default Secure Boot keys when System is in Setup Mode.

### Install Default Secure Boot Keys

Please install default secure boot keys if it's the first time you use secure boot.

### Enroll Efi Image

Allow the image to run in Secure Boot mode. Enroll SHA256 hash of the binary into Authorized Signature Database (db).

### Platform Key(PK)

Enroll Factory Defaults or load certificates from a file:

1. Public Key Certificate in:

- a) EFI\_SIGNATURE\_LIST
- b) EFI\_CERT\_X509 (DER encoded)
- c) EFI\_CERT\_RSA2048 (bin)

d) EFI\_CERT\_SHA256, 384, 512

2. Authenticated UEFI Variable

3. EFI PE/COFF Image(SHA256)

Key Source: Default, External, Mixed, Test

## Key Exchange Keys

Enroll Factory Defaults or load certificates from a file:

1. Public Key Certificate in:

a) EFI\_SIGNATURE\_LIST

b) EFI\_CERT\_X509 (DER encoded)

c) EFI\_CERT\_RSA2048 (bin)

d) EFI\_CERT\_SHA256, 384, 512

2. Authenticated UEFI Variable

3. EFI PE/COFF Image(SHA256)

Key Source: Default, External, Mixed, Test

## Authorized Signatures

Enroll Factory Defaults or load certificates from a file:

1. Public Key Certificate in:

a) EFI\_SIGNATURE\_LIST

b) EFI\_CERT\_X509 (DER encoded)

c) EFI\_CERT\_RSA2048 (bin)

d) EFI\_CERT\_SHA256, 384, 512

2. Authenticated UEFI Variable

3. EFI PE/COFF Image(SHA256)

Key Source: Default, External, Mixed, Test

## Forbidden Signatures

Enroll Factory Defaults or load certificates from a file:

1. Public Key Certificate in:

- a) EFI\_SIGNATURE\_LIST
  - b) EFI\_CERT\_X509 (DER encoded)
  - c) EFI\_CERT\_RSA2048 (bin)
  - d) EFI\_CERT\_SHA256, 384, 512
2. Authenticated UEFI Variable
  3. EFI PE/COFF Image(SHA256)

Key Source: Default, External, Mixed, Test

## Authorized TimeStamps

Enroll Factory Defaults or load certificates from a file:

1. Public Key Certificate in:
  - a) EFI\_SIGNATURE\_LIST
  - b) EFI\_CERT\_X509 (DER encoded)
  - c) EFI\_CERT\_RSA2048 (bin)
  - d) EFI\_CERT\_SHA256, 384, 512
2. Authenticated UEFI Variable
3. EFI PE/COFF Image(SHA256)

Key Source: Default, External, Mixed, Test

## OsRecovery Signatures

Enroll Factory Defaults or load certificates from a file:

1. Public Key Certificate in:
  - a) EFI\_SIGNATURE\_LIST
  - b) EFI\_CERT\_X509 (DER encoded)
  - c) EFI\_CERT\_RSA2048 (bin)
  - d) EFI\_CERT\_SHA256, 384, 512
2. Authenticated UEFI Variable
3. EFI PE/COFF Image(SHA256)

Key Source: Default, External, Mixed, Test

## 3.5 Boot Screen

In this section, it will display the available devices on your system for you to configure the boot settings and the boot priority.

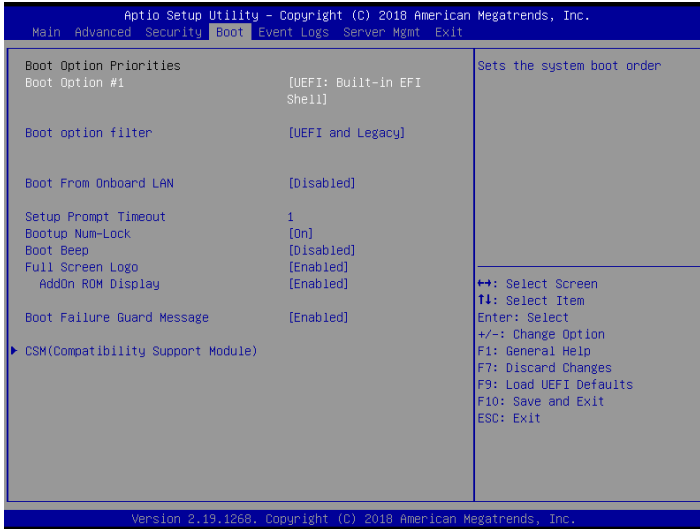

### Boot Option #1

Use this item to set the system boot order.

### Boot Option Filter

This option controls Legacy/UEFI ROMs priority.

### Boot From Onboard LAN

Use this item to enable or disable the Boot From Onboard LAN feature.

### Setup Prompt Timeout

Configure the number of seconds to wait for the UEFI setup utility.

### Bootup Num-Lock

If this item is set to [On], it will automatically activate the Numeric Lock function after boot-up.

### Boot Beep

Select whether the Boot Beep should be turned on or off when the system boots up. Please

---

note that a buzzer is needed.

### Full Screen Logo

Use this item to enable or disable OEM Logo. The default value is [Enabled].

### AddOn ROM Display

Use this option to adjust AddOn ROM Display. If you enable the option “Full Screen Logo” but you want to see the AddOn ROM information when the system boots, please select [Enabled]. Configuration options: [Enabled] and [Disabled]. The default value is [Enabled].

### Boot Failure Guard Message

If the computer fails to boot for a number of times the system automatically restores the default settings.

## 3.5.1 CSM Parameters

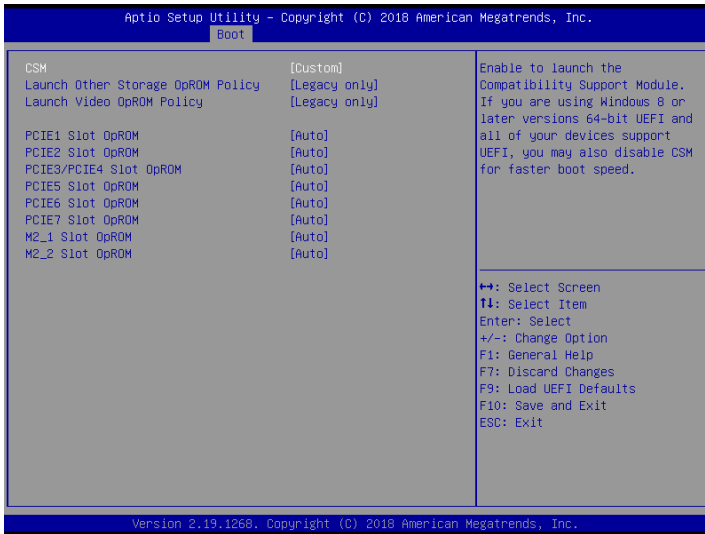

### CSM

Enable to launch the Compatibility Support Module. Please do not disable unless you're running a WHCK test. If you are using Windows 10 64-bit and all of your devices support UEFI, you may also disable CSM for faster boot speed.

### Launch Other Storage OpROM Policy

Select UEFI only to run those that support UEFI option ROM only. Select Legacy only to run those that support legacy option ROM only. Select Do not launch to not execute both legacy and UEFI option ROM.

### Launch Video OpROM Policy

Select UEFI only to run those that support UEFI option ROM only. Select Legacy only to run those that support legacy option ROM only. Select Do not launch to not execute both legacy and UEFI option ROM.

### PCI E1 Slot OpROM

Use this item to select slot storage and Network Option ROM policy. In Auto option, the default is Disabled with NVMe device, but it is Legacy with other devices. (This item can't select Video Option ROM policy.)

## PCIE2 Slot OpROM

Use this item to select slot storage and Network Option ROM policy. In Auto option, the default is Disabled with NVMe device, but it is Legacy with other devices. (This item can't select Video Option ROM policy.)

## PCIE3/PCIE4 Slot OpROM

Use this item to select slot storage and Network Option ROM policy. In Auto option, the default is Disabled with NVMe device, but it is Legacy with other devices. (This item can't select Video Option ROM policy.)

## PCIE5 Slot OpROM

Use this item to select slot storage and Network Option ROM policy. In Auto option, the default is Disabled with NVMe device, but it is Legacy with other devices. (This item can't select Video Option ROM policy.)

## PCIE6 Slot OpROM

Use this item to select slot storage and Network Option ROM policy. In Auto option, the default is Disabled with NVMe device, but it is Legacy with other devices. (This item can't select Video Option ROM policy.)

## PCIE7Slot OpROM

Use this item to select slot storage and Network Option ROM policy. In Auto option, the default is Disabled with NVMe device, but it is Legacy with other devices. (This item can't select Video Option ROM policy.)

## M2\_1 Slot OpROM

Use this item to select slot storage and Network Option ROM policy. In Auto option, the default is Disabled with NVMe device, but it is Legacy with other devices. (This item can't select Video Option ROM policy.)

## M2\_1 Slot OpROM

Use this item to select slot storage and Network Option ROM policy. In Auto option, the default is Disabled with NVMe device, but it is Legacy with other devices. (This item can't select Video Option ROM policy.)

## M2\_2 Slot OpROM

Use this item to select slot storage and Network Option ROM policy. In Auto option, the default is Disabled with NVMe device, but it is Legacy with other devices. (This item can't select Video Option ROM policy.)



## 3.6 Event Logs

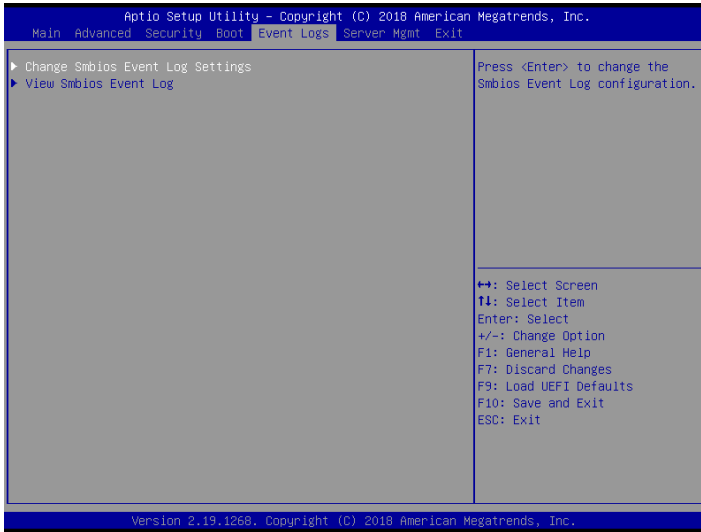

### Change Smbios Event Log Settings

This allows you to configure the Smbios Event Log Settings.

When entering the item, you will see the followings:

#### Smbios Event Log

Use this item to enable or disable all features of the SMBIOS Event Logging during system boot.

#### Erase Event Log

The options include [No], [Yes, Next reset] and [Yes, Every reset]. If Yes is selected, all logged events will be erased.

#### When Log is Full

Use this item to choose options for reactions to a full Smbios Event Log. The options include [Do Nothing] and [Erase Immediately].

#### Log System Boot Event

Choose option to enable/disable logging of System boot event.

#### MECI (Multiple Event Count Increment)

Use this item to enter the increment value for the multiple event counter. The valid range is from 1 to 255.

#### METW (Multiple Event Time Window)

Use this item to specify the number of minutes which must pass between duplicate log

entries which utilize a multiple-event counter. The value ranges from 0 to 99 minutes.

### View Smbios Event Log

Press <Enter> to view the Smbios Event Log records.



*All values changed here do not take effect until computer is restarted.*

## 3.7 Server Mgmt

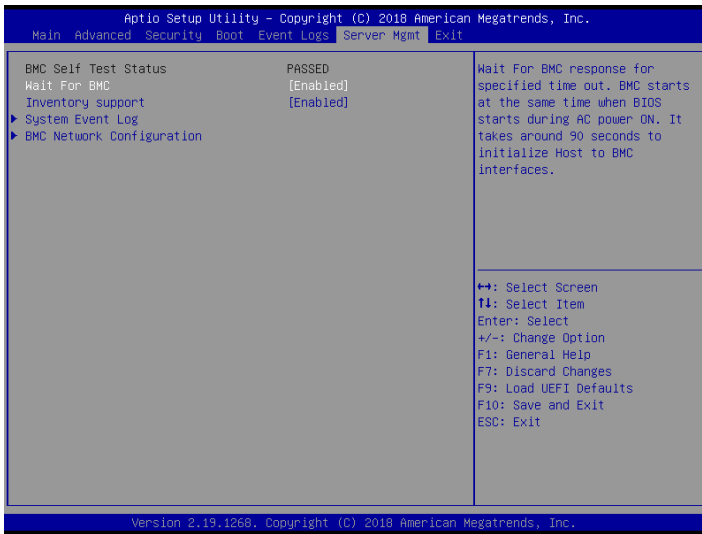

### Wait For BMC

Wait For BMC response for specified time out. BMC starts at the same time when BIOS starts during AC power ON. It takes around 90 seconds to initialize Host to BMC interfaces.

### Inventory Support

This will execute inventory function for system. Enabling this item will take some time at system boot.

## 3.7.1 System Event Log

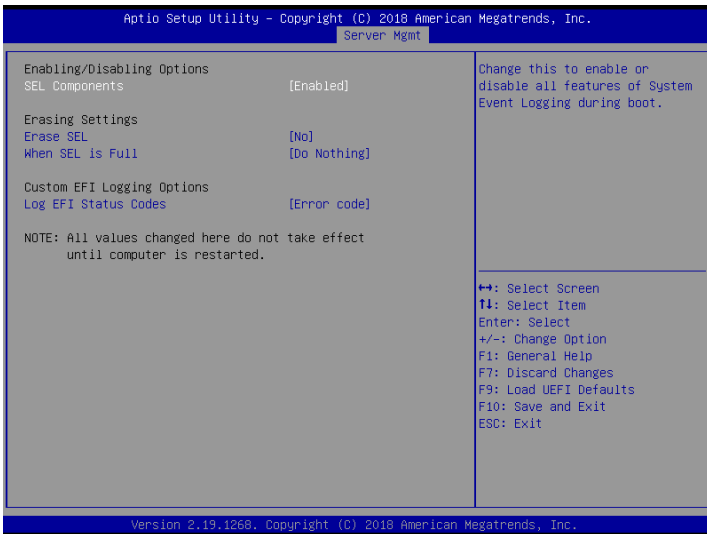

### SEL Components

Change this to enable or disable all features of System Event Logging during boot.

### Erase SEL

Use this to choose options for erasing SEL.

### When SEL is Full

Use this to choose options for reactions to a full SEL.

### Log EFI Status Codes

Use this item to disable the logging of EFI Status Codes or log only error code or only progress or both.

## 3.7.2 BMC Network Configuration

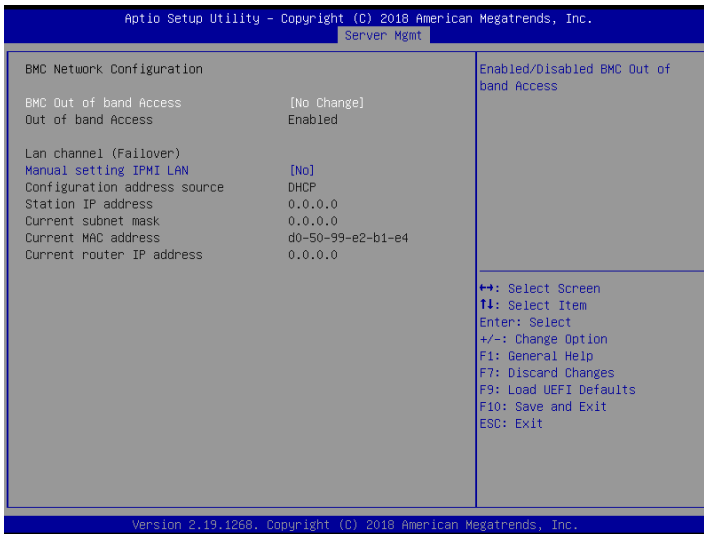

### BMC Out of Band Access

Enabled/Disabled BMC Out of band Access.

### Lan Channel (Failover)

### Manual Setting IPMI LAN

If [No] is selected, the IP address is assigned by DHCP. If you prefer using a static IP address, toggle to [Yes], and the changes take effect after the system reboots. The default value is [No].

### Configuration Address Source

Select to configure BMC network parameters statically or dynamically (by BIOS or BMC). Configuration options: [Static] and [DHCP].

**Static:** Manually enter the IP Address, Subnet Mask and Gateway Address in the BIOS for BMC LAN channel configuration.

**DHCP:** IP address, Subnet Mask and Gateway Address are automatically assigned by the network's DHCP server.



When [DHCP] or [Static] is selected, do NOT modify the BMC network settings on the IPMI web page.



*The default login information for the IPMI web interface is:*

*Username: admin*

*Password: admin*

*For more instructions on how to set up remote control environment and use the IPMI management platform, please refer to the IPMI Configuration User Guide or go to the Support website at: <http://www.asrockrack.com/support/faq.asp>*

## 3.8 Exit Screen

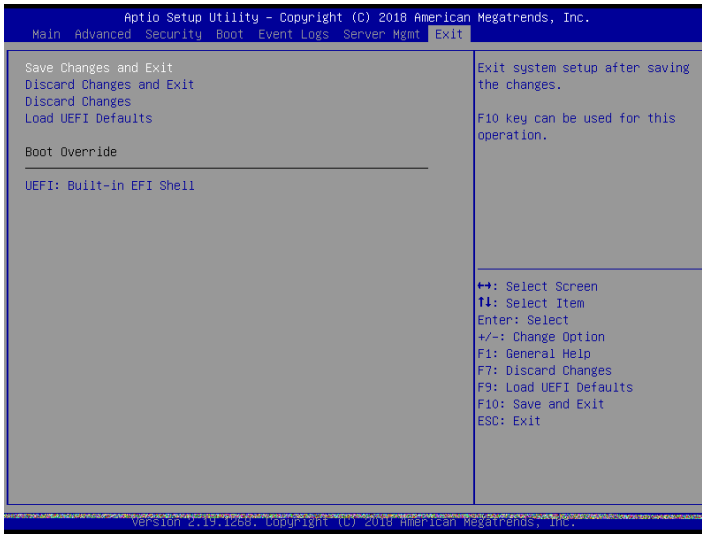

### Save Changes and Exit

When you select this option, the following message “Save configuration changes and exit setup?” will pop-out. Press <F10> key or select [Yes] to save the changes and exit the UEFI SETUP UTILITY.

### Discard Changes and Exit

When you select this option, the following message “Discard changes and exit setup?” will pop-out. Press <ESC> key or select [Yes] to exit the UEFI SETUP UTILITY without saving any changes.

### Discard Changes

When you select this option, the following message “Discard changes?” will pop-out. Press <F7> key or select [Yes] to discard all changes.

### Load UEFI Defaults

Load UEFI default values for all the setup questions. F9 key can be used for this operation.

### Boot Override

These items displays the available devices. Select an item to start booting from the selected device.

# Chapter 4 Software Support

## 4.1 Install Operating System

This motherboard supports various Microsoft® Windows® 2012 R2 / 2016 / Linux® compliant. Because motherboard settings and hardware options vary, use the setup procedures in this chapter for general reference only. Refer to your OS documentation for more information.

*\*Please download the Intel® SATA Floppy Image driver from the ASRock Rack's website ([www.asrockrack.com](http://www.asrockrack.com)) to your USB drive or simply install the SATA driver from the Support CD while installing OS in SATA RAID mode.*

*\* Before installing the Linux OS, please first enter the BIOS settings, go to "Advanced" > "Chipset Configuration" and set "IGPU Multi-Monitor" option to "Disabled".*

## 4.2 Support CD Information

The Support CD that came with the motherboard contains necessary drivers and useful utilities that enhance the motherboard's features.

### 4.2.1 Running The Support CD

To begin using the support CD, insert the CD into your CD-ROM drive. The CD automatically displays the Main Menu if "AUTORUN" is enabled in your computer. If the Main Menu does not appear automatically, locate and double click on the file "ASRSetup.exe" from the root folder in the Support CD to display the menu.

### 4.2.2 Drivers Menu

The Drivers Menu shows the available device's drivers if the system detects installed devices. Please install the necessary drivers to activate the devices.

### 4.2.3 Utilities Menu

The Utilities Menu shows the application softwares that the motherboard supports. Click on a specific item then follow the installation wizard to install it.

### 4.2.4 Contact Information

If you need to contact ASRock Rack or want to know more about ASRock Rack, welcome to visit ASRock Rack's website at <http://www.ASRockRack.com>; or you may contact your dealer for further information.



# Chapter 5 Troubleshooting

## 5.1 Troubleshooting Procedures

Follow the procedures below to troubleshoot your system.



*Always unplug the power cord before adding, removing or changing any hardware components. Failure to do so may cause physical injuries to you and damages to motherboard components.*

1. Disconnect the power cable and check whether the PWR LED is off.
2. Unplug all cables, connectors and remove all add-on cards from the motherboard.  
Make sure that the jumpers are set to default settings.
3. Confirm that there are no short circuits between the motherboard and the chassis.
4. Install a CPU and fan on the motherboard, then connect the chassis speaker and power LED.

### **If there is no power...**

1. Confirm that there are no short circuits between the motherboard and the chassis.
2. Make sure that the jumpers are set to default settings.
3. Check the settings of the 115V/230V switch on the power supply.
4. Verify if the battery on the motherboard provides ~3VDC. Install a new battery if it does not.

### **If there is no video...**

1. Try replugging the monitor cables and power cord.
2. Check for memory errors.

### **If there are memory errors...**

1. Verify that the DIMM modules are properly seated in the slots.
2. Use recommended DDR4 R DIMM/LR DIMM /NVDIMMs.
3. If you have installed more than one DIMM modules, they should be identical with the same brand, speed, size and chip-type.
4. Try inserting different DIMM modules into different slots to identify faulty ones.
5. Check the settings of the 115V/230V switch on the power supply.

---

**Unable to save system setup configurations...**

1. Verify if the battery on the motherboard provides ~3VDC. Install a new battery if it does not.
2. Confirm whether your power supply provides adequate and stable power.

**Other problems...**

1. Try searching keywords related to your problem on ASRock Rack's FAQ page:  
<http://www.asrockrack.com/support>

## 5.2 Technical Support Procedures

If you have tried the troubleshooting procedures mentioned above and the problems are still unsolved, please contact ASRock Rack's technical support with the following information:

1. Your contact information
2. Model name, BIOS version and problem type.
3. System configuration.
4. Problem description.

You may contact ASRock Rack's technical support at:

<http://www.asrockrack.com/support/tsd.asp>

## 5.3 Returning Merchandise for Service

For warranty service, the receipt or a copy of your invoice marked with the date of purchase is required. By calling your vendor or going to our RMA website (<http://event.asrockrack.com/tsd.asp>) you may obtain a Returned Merchandise Authorization (RMA) number.

The RMA number should be displayed on the outside of the shipping carton which is mailed prepaid or hand-carried when you return the motherboard to the manufacturer. Shipping and handling charges will be applied for all orders that must be mailed when service is complete.

This warranty does not cover damages incurred in shipping or from failure due to alteration, misuse, abuse or improper maintenance of products.

Contact your distributor first for any product related problems during the warranty period.